

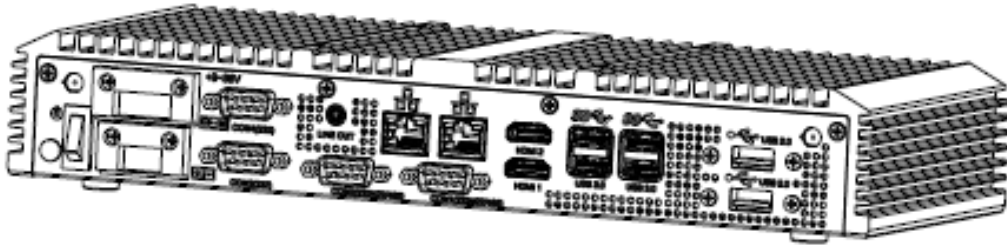

Novakon Fanless Embedded Box PC – NBP Series



NBP-01

Fanless Embedded Box PC

Intel® Celeron® J6412

User Manual

P/N:1306.0027 V1.1

Release Date: July, 2024

©2024 Copyrights Reserved



Warning!

This equipment generates, uses and can radiate radio frequency energy and if not installed and used in accordance with the instruction manual, it may cause interference to radio communications. It has been tested and found to comply with the limits for a Class A computing device pursuant to FCC Rules, which are designed to provide reasonable protection against such interference when operated in a commercial environment. Operation of this equipment in a residential area is likely to cause interference in which case the user at his own expense will be required to take whatever measures may be required to correct the interference.

Electric Shock Hazard – Do not operate the machine with its back cover removed. There are dangerous high voltages inside.

Caution

Risk of explosion if the battery is replaced with an incorrect type. Batteries should be recycled where possible. Disposal of used batteries must be in accordance with local environmental regulations.

Safety Precautions

Follow the messages below to prevent your systems from damage:

- ◆ Avoid your system from static electricity on all occasions.
- ◆ Prevent electric shock. Do not touch any components of this card when the card is power-on. Always disconnect power when the system is not in use.
- ◆ Disconnect power when you change any hardware devices. For instance, when you connect a jumper or install any cards, a surge of power may damage the electronic components or the whole system.

Table of Contents

Warning!	1
Caution	1
Safety Precautions	1
Chapter 1 Getting Started.....	3
1.1 Features	3
1.2 Specifications	3
1.3 Dimensions & Rear I/O	4
1.4 Brief Description of NBP-01	5
1.5 DC-IN Power Connector.....	6
1.6 Remote Power Switch.....	6
1.7 COM1,COM2,COM3,COM4 Port Pin Define.....	6
1.8 VESA Mounting.....	7
1.9 Desk Mounting	8
1.10 DIN rail Mounting	8
1.11 Wall Mounting	10
Chapter 2 Hardware.....	11
2.1 Motherboard Introduction	11
2.2 Specifications	11
2.3 Jumpers and Connectors Location.....	14
2.4 Jumpers Setting and Connectors	16
Chapter 3 BIOS Setup	25
3.1 Introduction	25
3.1.1 How to Entering into BIOS menu	25
3.1.2 Function Keys to setup in BIOS Setup program	25
3.2 The Main Menu	26
3.3 Advanced	27
3.4 Chipset.....	40
3.5 Security	42
3.6 Boot.....	45
3.7 Save & Exit.....	46
Chapter 4 Installation Setup	47
4.1 Wi-Fi6 & Bluetooth 5.2 Module Installation Kit List.....	47
4.2 4G & LTE Module Installation Kit List.....	49

Chapter 1 Getting Started

1.1 Features

- Industrial Compact Size Box PC
- Fanless design
- Intel® Celeron® J6412 (2.0 GHz) CPU
- DC 9~36V wide-ranging power input

1.2 Specifications

NBP-01	
System	
CPU	Onboard Intel Celeron J6412 (2.0 GHz)
Chipset	SoC
Memory	16GB DDR4 3200 MHz (32GB Optional)
I/O Port	
USB	4 x USB 3.2 Gen 1, 2 x USB 2.0
Serial	1 x DB9 (RS-232/422/485 & RI/5V/12V) 1 x DB9 (RS-232/422/485) 2 x DB9 (RS-232)
Audio	1 x Audio Line Out
LAN	2 x GbE LAN RJ-45
HDMI	2 x HDMI 2.0
Power	1 x 2 pins terminal block for external power switch 1 x 3 pins terminal block power connector 1 x power switch on/off
Storage Space	
Storage (SSD)	1 x 2280 M.2 M-Key (PCIe x2, SATA 6Gb/s)
Expansion	
Expansion Slot	1 x Full-size mini PCIe
Power	
Power Input	DC 9~36V
Mechanical	
Construction	Metal Housing

Environmental	
Operating temperature	0~50°C
Storage temperature	-20~60°C
Humidity	10 to 90% @ 40°C, non- condensing
Certification	CE / FCC Class A
Operating System Support	
OS Support	Windows 10 IoT, Debian 11

1.3 Dimensions & Rear I/O

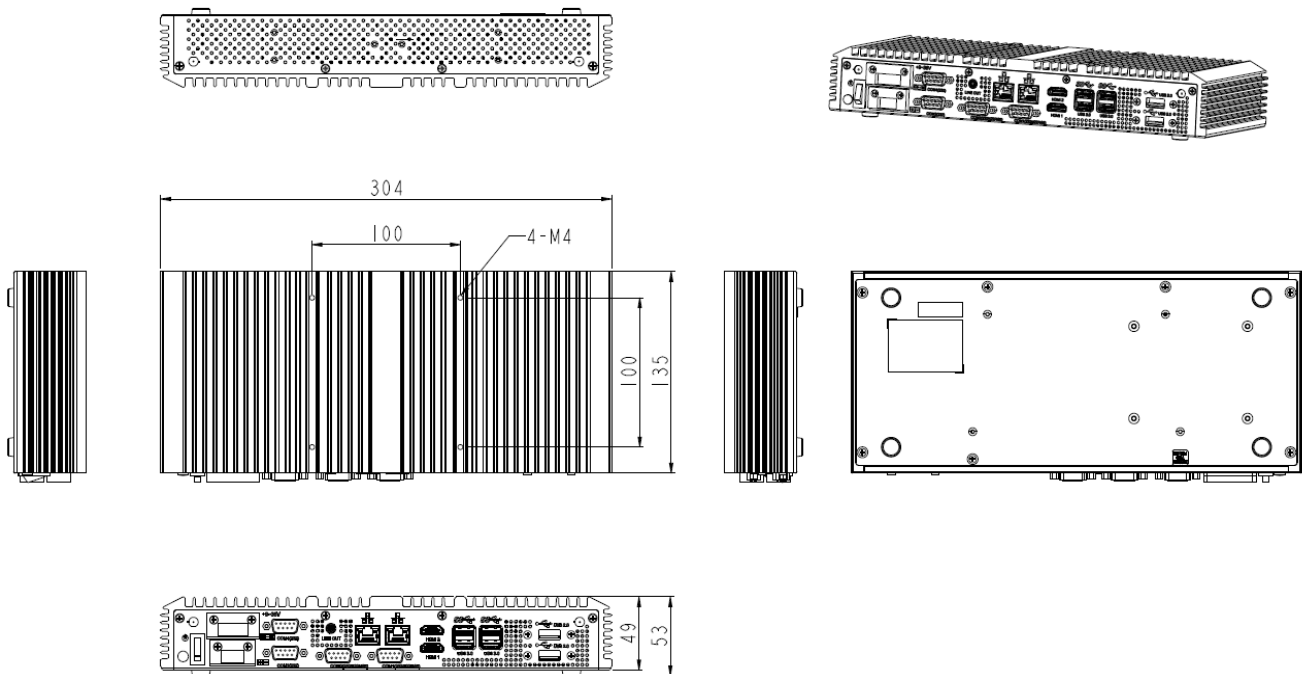
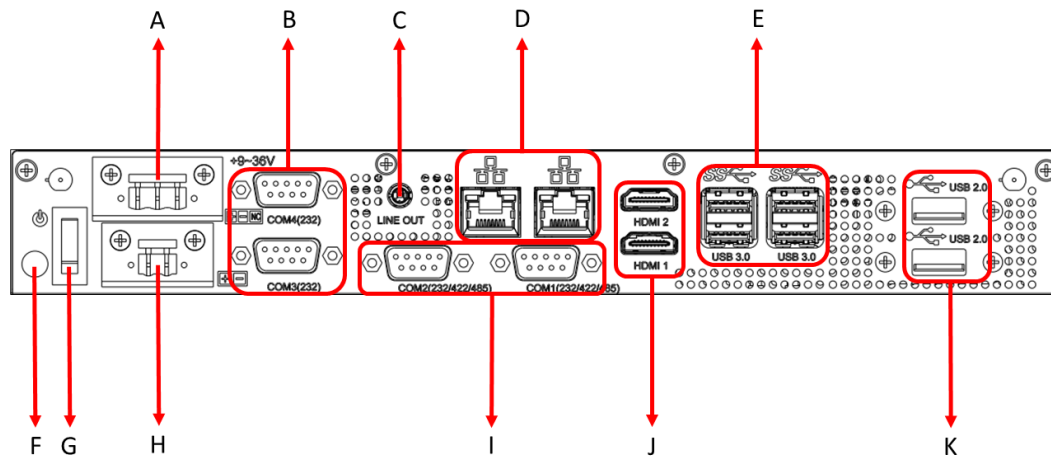

Figure 1.1: Dimensions of NBP-01



- | | |
|-------------------------|-------------------------------|
| A. DC-IN (DC+9V~36V) | G. Power Switch |
| B. COM3&COM4 (RS-232) | H. Remote Power Switch |
| C. Audio Line Out | I. COM1&COM2 (RS-232/422/485) |
| D. LAN1&2 (10/100/1000) | J. HDMI1 & HDMI2 |
| E. USB 3.2 x4 | K. USB 2.0 x2 |
| F. Power LED (Green) | |

Figure 1.2: Rear I/O Port Placement

1.4 Brief Description of NBP-01

This is a Fanless Embedded Box PC, powered by Intel J6412 (2.0 GHz) Quad Core processor, 8GB DDR4 3200MHz memory (16GB/32GB memory is for option), supporting DC 9~36V wide input voltage range. The model is ideal for use as PC-based controller for industrial edge computing and factory automation.

1.5 DC-IN Power Connector

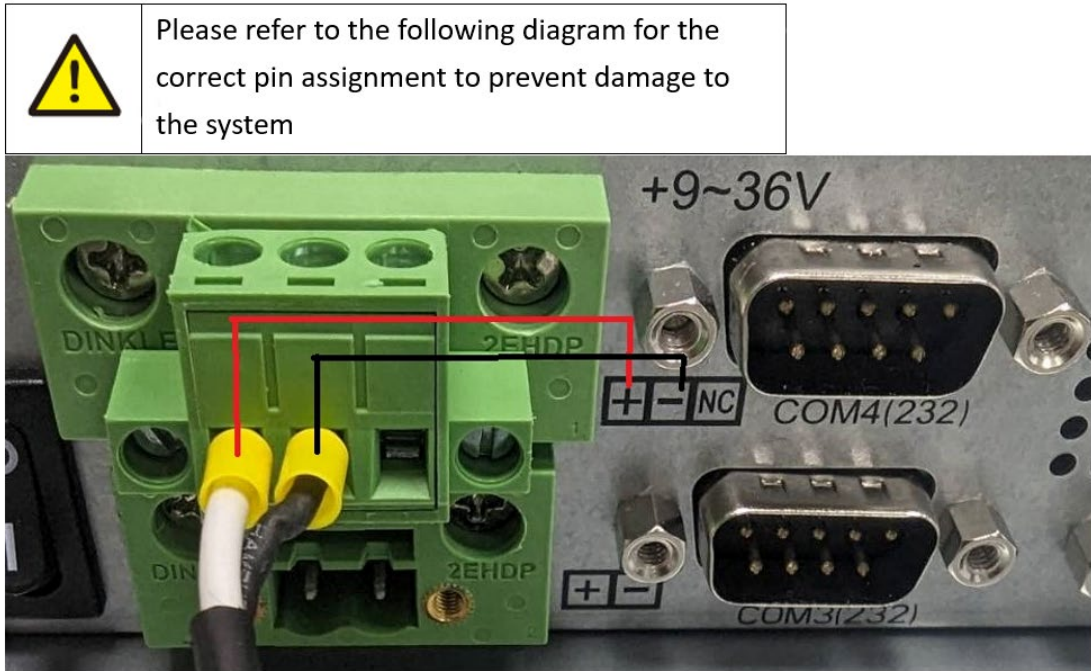

Figure 1.3: Power IN Cable & Connector Location

1.6 Remote Power Switch

Link the Remote Power Switch connector to the switch lines

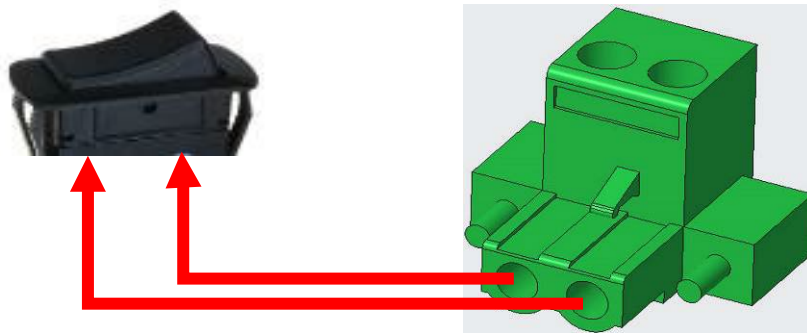
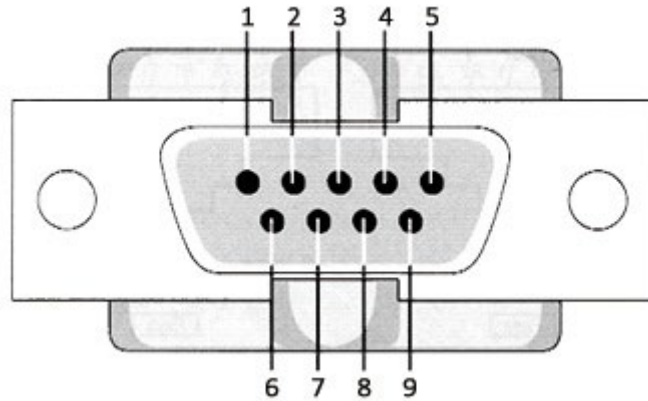

Figure 1.4: Power Switch Link Cable & Connector Layout

1.7 COM1,COM2,COM3,COM4 Port Pin Define



Pin#	RS-422	Pin No.	RS-485	Pin#	RS-232	Pin No.	RS-232
1	TXD-	1	D-	1	DCD	6	DSR
2	TXD+	2	D+	2	RXD	7	RTS
3	RXD+			3	TXD	8	CTS
4	RXD-			4	DTR	9	RI/5V/12V (COM1 Only)
				5	GND		

1.8 VESA Mounting

The NBP-01 is designed to be VESA mounted as shown in Picture. Just carefully place the unit through the hole and tighten the given screws from the rear to secure the mounting.

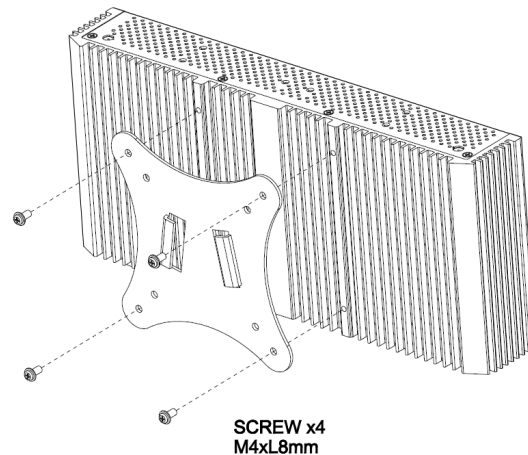

Figure 1.3: VESA Mounting

1.9 Desk Mounting

Install the box PC under the desktop and secure it with T4 x L >19mm (3/4") screws

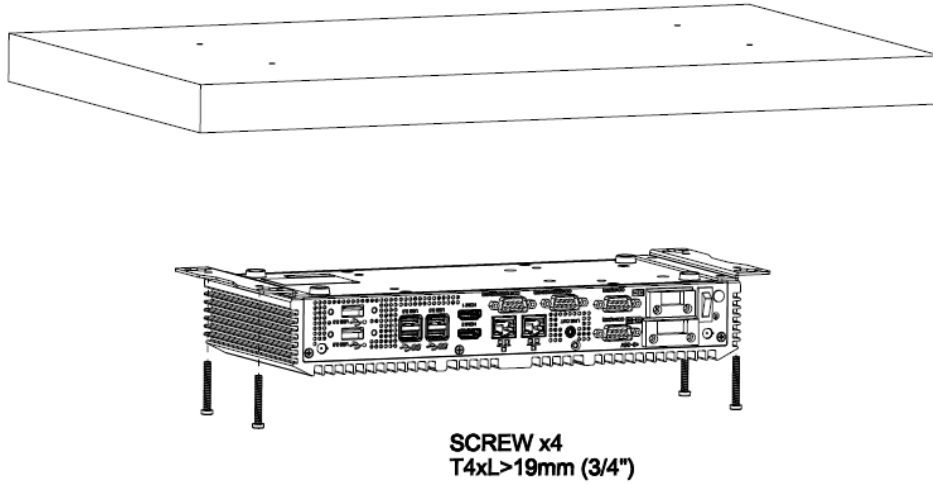
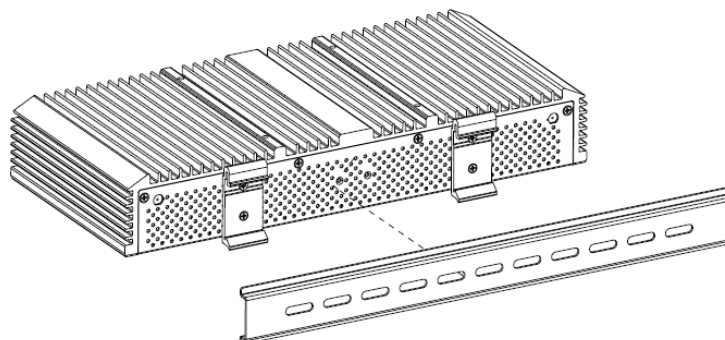
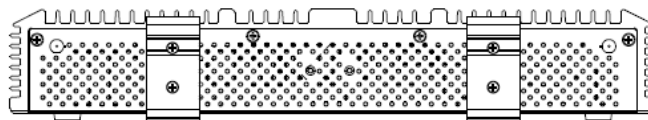

Figure 1.4: Desk Mounting

1.10 DIN rail Mounting

Please follow these steps to mount the hook kit on a DIN-rail.

1. Screw the provided din-rail kit on the rear side of the box PC as the diagram shown below.



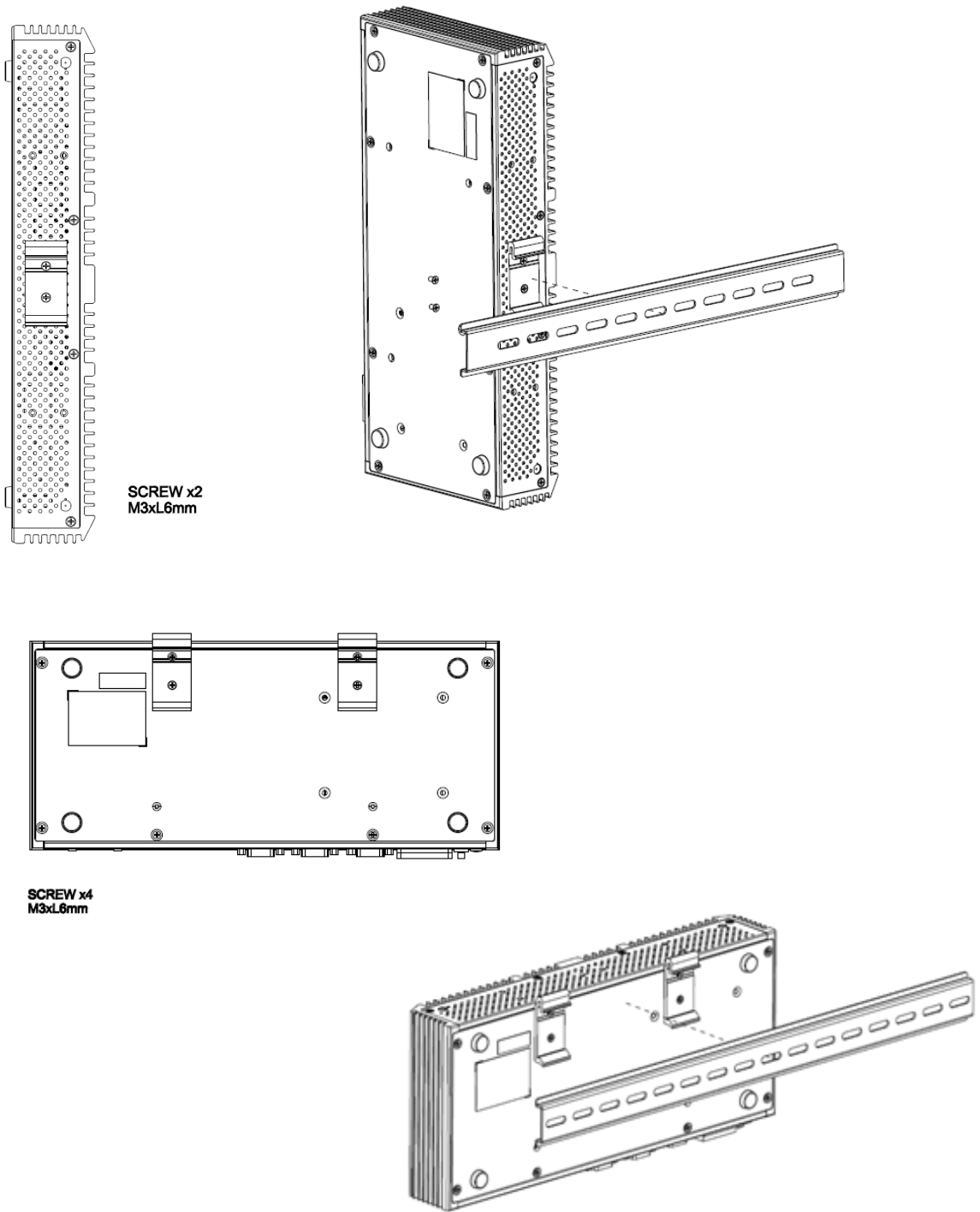
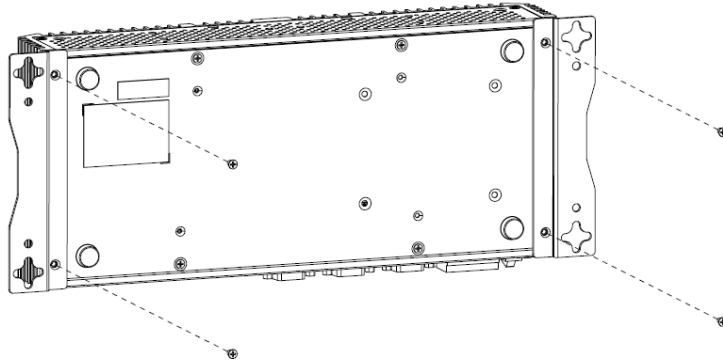

Figure 1.5: DIN Rail Mounting

1.11 Wall Mounting

1. Remove the original 4 screws as shown in the picture and install the wall mount bracket.



2. Secure the screws at the position of 322.7x113mm on the wall.

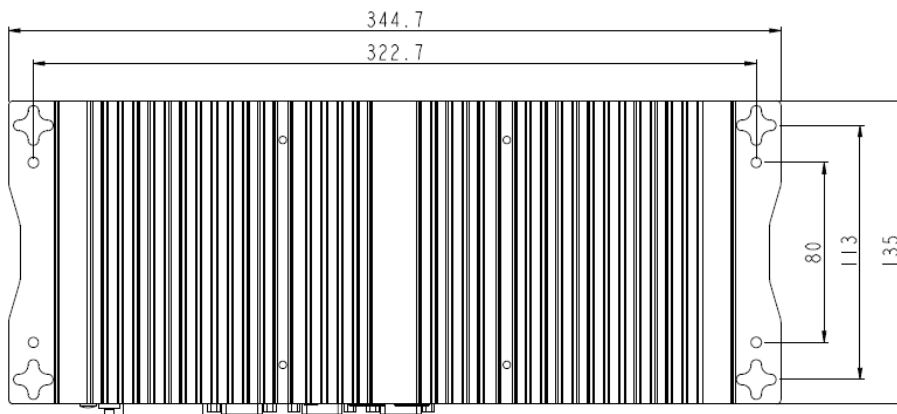

3. Hang the Box PC on the wall.

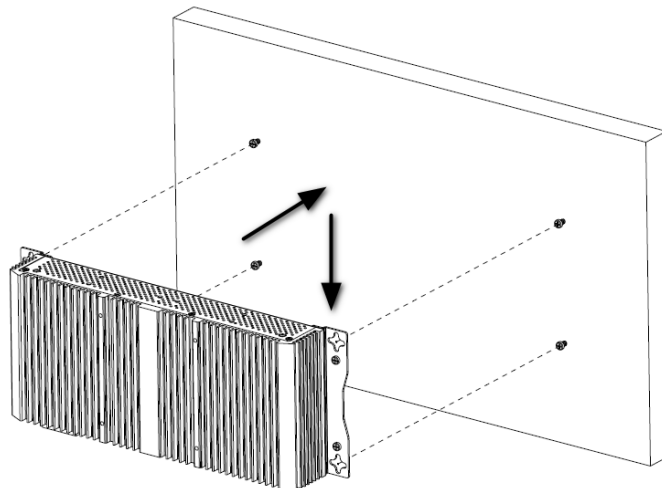

Chapter 2 Hardware

2.1 Motherboard Introduction

A 3.5" industrial motherboard developed on the basis of Intel Celeron Processors, which provides abundant peripheral interfaces to meet the needs of different customers. Also, it features dual GbE ports, 4-COM ports and one Mini PCIe configuration, six USB ports, two HDMI ports, one LVDS interface. To satisfy the special needs of high-end customers. The product is widely used in various sectors of industrial control.

2.2 Specifications

Specifications	
Board Size	146mm x 101.7mm
CPU Support	Onboard Intel® Celeron® J6412 2.0GHz, quad-core, 4 threads, (up to 2.6GHz)
Chipset	SoC
BIOS	AMI/UEFI
Memory Support	2 x SO-DIMM, DDR4 3200MHz, up to 32GB
Graphics	Intel® UHD Graphics 400/800MHz
Display Mode	2 x HDMI Ports 1 x LVDS (18/24-bit dual LVDS)
Support Resolution	Up to 4096 x 2160 for HDMI Up to 1920 x 1200 for LVDS
Triple Display	2 x HDMI + LVDS
Storage	1 x SATA 6Gb/s Port (CN13)
Ethernet	2 x GbE LAN Ports (Intel® I211AT) (CN23)
USB	4 x USB 3.2 Gen 1 External I/O port (CN25) 2 x USB 2.0 Pin headers (CN14)
Serial	1 x COM header (RS-232/422/485 & RI/5V/12V) (CN6:COM1) 1 x COM header (RS-232/422/485) (CN6:COM2) 2 x COM headers (RS-232) (CN6:COM3, COM4)
Digital I/O	1 x GPIO (8 bits) & SMBus header (CN15)
Battery	Support CR2032 battery by 2-pin header (CN21)
Audio	Realtek® Audio Codec

	Support Line-out (CN22) Front panel audio header (CN8)
Expansion Slots	1 x 2280 M.2 M-Key (PCIe x2, SATA 6Gb/s) (CN11) 1 x Full-size mini PCIe with SIM slot (CN19)
Power Management	Wide Range DC9V~36V input 1 x 4-pin power input connector (CN2)
Switches and LED Indicators	Front panel header 1 x Power on/off switch (CN10) 1 x Reset (CN10) 1 x Power LED status (CN10) 1 x HDD LED status (CN10)
External I/O port	1 x Headphone Jack 2 x HDMI 2 x RJ45 LAN Ports 4 x USB 3.2 Gen 1
Temperature	Operating: 0°C to 60°C Storage: -40°C to 85°C
Humidity	0% - 90%, non-condensing, operating
EMI/EMS	Meet CE/FCC class A

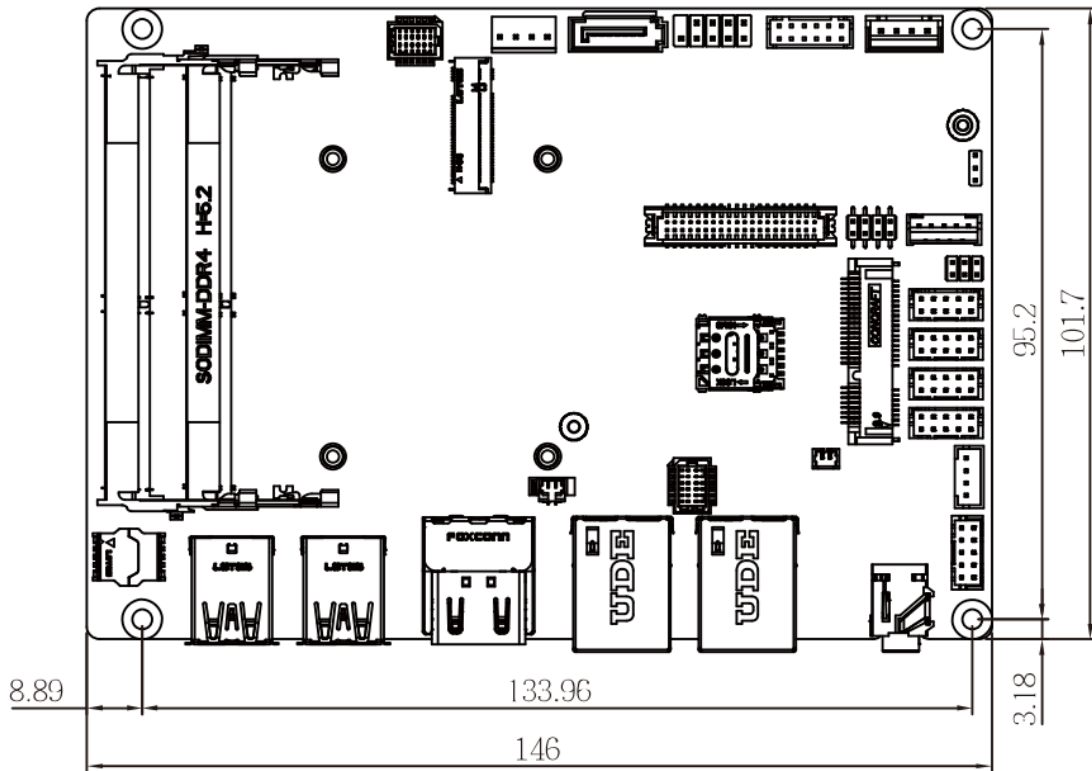

Figure 2.1: Motherboard Dimensions

2.3 Jumpers and Connectors Location

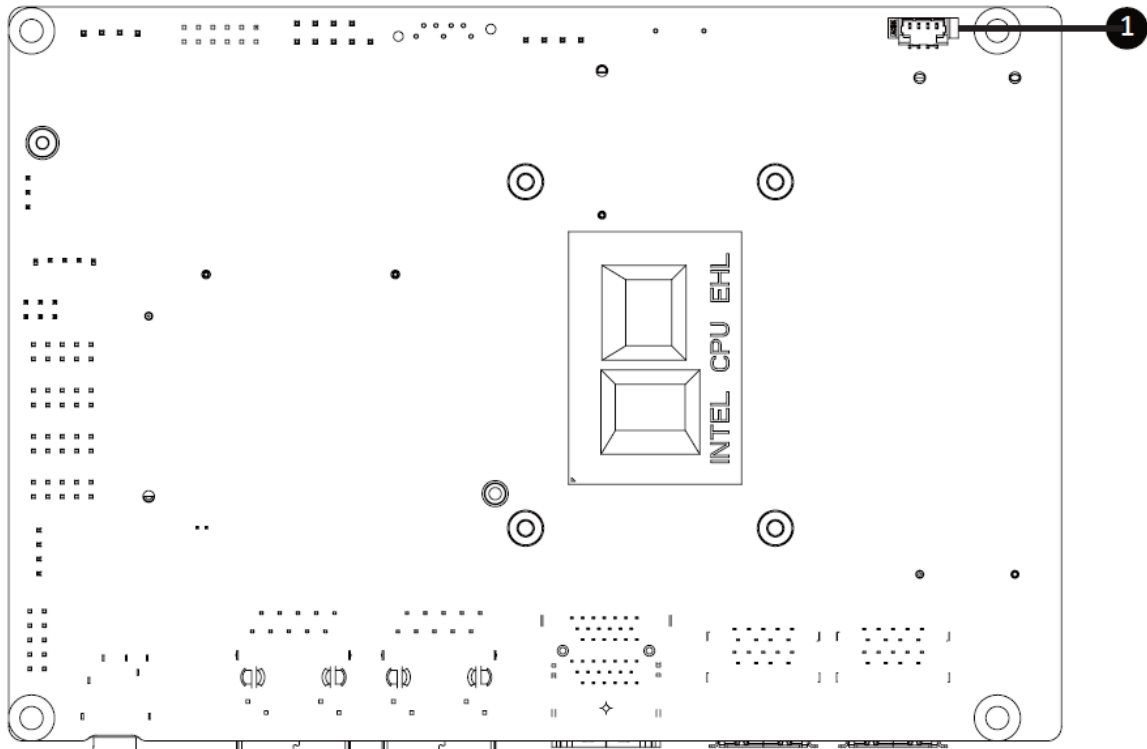

Figure 2.2: Connectors Location-Bottom Board

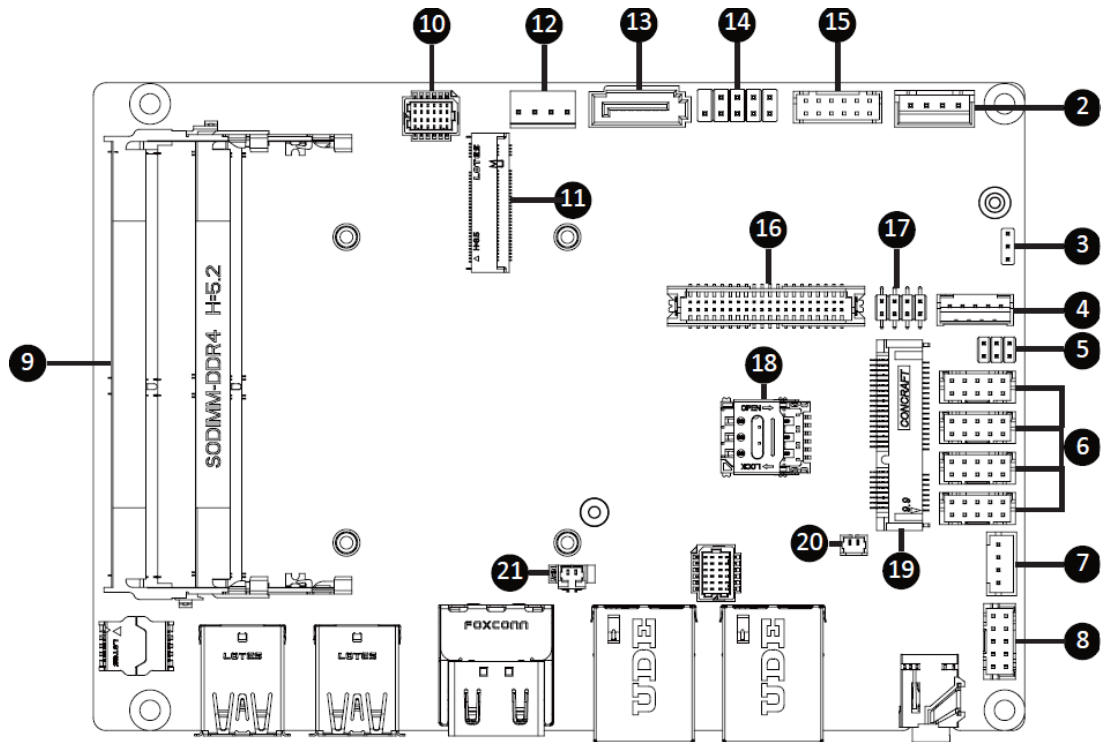

Figure 2.3: Connectors Location-Top Board

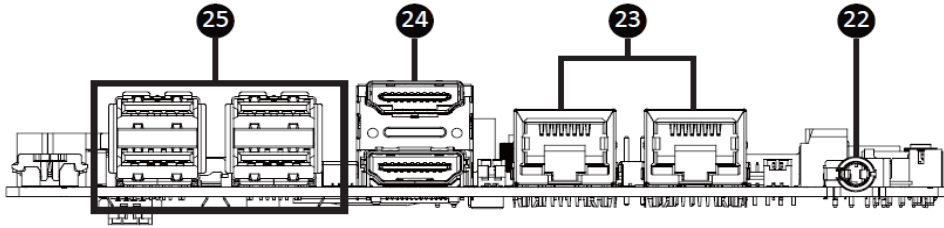

Figure 2.4: Rear I/O Connectors Location

No	Code	Description
1	FAN	FAN connector
2	DC_IN	DC IN 1x4pin power connector
3	AT_CN	AT/ATX mode select jumper
4	BKL_CN	Backlight Control connector
5	JCOM1	RI# pin RI#/5V/12V select jumper for COM1 port
6	COM1	Serial port header
	COM2	COM1 : RS-232/422/485 & RI/5V/12V
	COM3	COM2 : RS-232/422/485
	COM4	COM3, COM4 : RS-232
7	SPKR	Speaker out connector
8	FP_AUDIO	Front panel audio header
9	SODIMMA	DDR4 SO-DIMM sockets x 2
	SODIMMB	
10	SYS_PANEL	Front panel header
11	M2M	M.2 slot, M-key, NGFF2280
12	SATAPW	SATA power connector
13	SATAIII	SATA 6Gb/s connector
14	FUSB20	USB 2.0 header
15	GPIO_CNT	General Purpose input/output header
16	LVDS	LVDS connector
17	LSW	LVDS resolution jumper
18	SIM_CARD	3G/4G SIM slot
19	MPCIE	Mini-PCIe slot
20	BUZZER	Buzzer header
21	BATTERY	Battery cable connector
22	AUDIO	Line out connector (Headphone without microphone)
23	LAN1, LAN2	LAN connector
24	HDMI	HDMI connector
25	USB31_1,	USB 3.2 Gen 1 connector x 4
	USB31_2	

2.4 Jumpers Setting and Connectors

1. FAN (FAN connector):

Fan connector cooling fans can be connected directly for use. You may set the rotation condition of cooling fan in menu of BIOS CMOS Setup. (1.25mm Pitch 1x4 Pin Header)

Pin#	Signal Name
1	Ground
2	+12VCC
3	FAN_Sense
4	Speed_Control

2. DC_IN (Power Connector):

DC12V System power input connector (2.5mm Pitch DC-IN 1x4pin Wafer Pin Header)

Pin#	Signal Name
1	Ground
2	Power Input DC+12V
3	Power Input DC+12V
4	Ground

2-1. Remote Power SW (System option):

This is used to connect power switch button. These two pins are disconnected under normal condition. You may short them temporarily to control system startup and shutdown or awaken the system from sleep mode.

3. AT_CN (AT/ATX mode select jumper)

AT/ATX mode select jumper	
	1-2 Close : AT mode.
	2-3 Close : ATX mode. (Default setting)

Pin#	Definition
1	AT MODE
2	Detect
3	ATX MODE

4. BKL_CN (Backlight Control connector):



(2.0mm Pitch 1x5 wafer Pin Header) Backlight control connector for LVDS.

Pin#	Signal Name
1	DC5V
2	BKLT_PWM
3	BKLT_EN
4	Ground
5	DC12V

5. JCOM1 (RI#/5V/12V Select jumper for COM1 Port):

COM1 Pin 1 to 6 are used to select signal out & pin 9 out voltage port.

(1.0mm Pitch 2x3 Pin Header)

JCOM1 Jumper Select	
	1-2 Close: 5V (Power COM)
	3-4 Close: RI (Stand COM)
	5-6 Close: 12V (Power COM)

6. COM1, COM2, COM3, COM4 (Serial port header):

COM1: Support RS-232/422/485 & RI/5V/12V For RI/5V/12V jumper setting, please see

COM2: Support RS-232/422/485

COM3 & COM4: Support RS-232 only

7. SPKR (Speaker out connector):

Pin#	Definition
1	Speaker Out L+
2	Speaker Out L-
3	Speaker Out R-
4	Speaker Out R+

8. FP_AUDIO (Front panel audio header):

(2.0mm Pitch 2X5 Pin Header), Front Audio, An onboard Realtek codec is used to provide high-quality audio I/O ports. Line Out can be connected to a headphone or amplifier. Line In is used for the connection of external audio source via a Line in cable. MIC is the port for microphone input audio.

Pin#	Definition	Pin#	Definition
1	MIC-LEFT	6	GND
2	GND	7	JACKSENCE Detect
3	MIC-RIGHT	8	NC
4	Detect	9	LINE-LEFT
5	LINE-RIGHT	10	GND

9. SODIMMA, SODIMMB (DDR4 SO-DIMM sockets):

2 x DDR4 SO-DIMM sockets, Max Capacity 32 GB Support Dual Channel DDR4 3200 MHz memory modules

10. SYS_PANEL (Front panel header):

Pin#	Definition	Pin#	Definition
1	HD-p	7	Reset Button
2	MPD-p	8	GND
3	HD-n	9	No Connect
4	MPD-n	10	No Connect
5	GND	11	No Connect
6	POWER-ON	12	No Connect

11. M2M (M.2 Slot, M-Key, NGFF 2280)

Please install the module card into the M.2 slot

Pin	Definition	Pin	Definition	29	PCIE1 RXn	30	NC
1	GND	2	3.3V	31	PCIE1 RXp	32	NC
3	GND	4	3.3V	33	GND	34	NC
5	NC	6	NC	35	PCIE2 TXn	36	NC
7	NC	8	NC	37	PCIE2 TXp	38	NC
9	GND	10	SSD LED	39	GND	40	NC
11	NC	12	3.3V	41	PCIE0 RXn/SATA Bp	42	NC
13	NC	14	3.3V	43	PCIE0 RXp/SATA Bn	44	NC
15	GND	16	3.3V	45	GND	46	NC
17	NC	18	3.3V	47	PCIE0 TXn/SATA An	48	NC
19	NC	20	NC	49	PCIE0 TXp/SATA Ap	50	PCI Reset
21	GND	22	NC	51	GND	52	PCIE Clock
23	NC	24	NC	53	PCIE Clock n	54	NC
25	NC	26	NC	55	PCIE Clock p	56	NC
27	GND	28	NC	57	GND	58	NC

12. SATA Power (SATA power connector):

One onboard 5V&12V output connector is reserved to provide power for SATA devices.

(2.5mm Pitch 1x4 box Pin Header)

Pin#	Signal Name
1	12V
2	Ground
3	Ground
4	5V

13. SATAIII (SATA 6Gb/s Connector):

One SATA connector is provided with transfer speed up to 6.0Gb/s. (SATA 7Pin+15Pin)

Definition	
1	GND
2	TXp
3	TXn
4	GND
5	RXn
6	RXp
7	GND

14. FUSB20 (USB 2.0 header)

Pin#	Definition	Pin#	Definition
1	5V	6	D1p
2	5V	7	GND
3	D2n	8	GND
4	D1n	9	No Pin
5	D2p	10	No Connect

15. GPIO_CNT (General Purpose input/output header):

(2.0mm Pitch 2X6 Pin Header) For expand connector, it provides eight GPIO.

Pin#	Definition	Pin#	Definition
1	GPIO-output_1	7	GPIO-output_4
2	GPIO-input_1	8	GPIO-input_4
3	GPIO-output_2	9	SMBus Clock
4	GPIO-input_2	10	SMBus DATA
5	GPIO-output_3	11	5V
6	GPIO-input_3	12	GND

16. LVDS (LVDS connector):

(1.25mm Pitch 2x20 Connector, DF13-40P), for 18/24-bit LVDS output connector, fully supported by DP to LVDS, the interface features dual channel 24-bit output. Low Voltage Differential Signaling, A high speed, low power data transmission standard used for display.

Pin	Definition	Pin	Definition	Pin	Definition	Pin	Definition
1	3.3V	11	A1-	21	A5+	31	GND
2	5V	12	A0-	22	A4+	32	GND
3	3.3V	13	GND	23	A5-	33	CLK2+
4	5V	14	GND	24	A4-	34	CLK1+
5	SPECO	15	A3+	25	GND	35	CLK2-
6	SPEDO	16	A2+	26	GND	36	CLK1-
7	GND	17	A3-	27	A7+	37	GND
8	GND	18	A2-	28	A6+	38	GND
9	A1+	19	GND	29	A7-	39	12V
10	A0+	20	GND	30	A6-	40	12V

17. LSW (LVDS resolution jumper)

LVDS Resolution Jumper	
Jumper Setting	Resolution
15.6": G156HCE-LN1(INX)	800 x 600 18bit (default)
18.5": G185HAN01.004(AUO)	1024 x 768 /18bit
21.5": G215HAN01.501(AUO)	1024 x 768 /24bit

18. SIM_CARD (3G/4G SIM Slot)

19. MPCIE (Mini PCIe slot)

Please install the Wi-Fi/ Bluetooth card into the M.2 slot.

Pin	Definition	Pin	Definition	27	GND	28	NC
1	PCIE WAKE	2	3.3V	29	GND	30	SMB Clock
3	NC	4	GND	31	PCIE TXn	32	SMB DATA
5	NC	6	NC	33	PCIE TXp	34	GND
7	PCIE Clock Request	8	SIM VCC	35	GND	36	USB Dn
9	GND	10	SIM DATA	37	GND	38	USB Dp
11	PCIE Clock n	12	SIM Clock	39	3.3V	40	GND
13	PCIE Clock p	14	SIM Reset	41	3.3V	42	NC
15	GND	16	UIM VPP3	43	GND	44	NC
17	NC	18	GND	45	NC	46	NC
19	NC	20	WLAN_DISABLE	47	NC	48	NC
21	GND	22	Reset	49	NC	50	GND
23	PCIE RXn	24	3.3V	51	NC	52	3.3V
25	PCIE RXp	26	GND	53	GND	54	GND

20. BUZZER (Buzzer header):

External buzzer

Pin#	Definition
1	Buzzer
2	5V

21. BATTERY:

(1.25mm Pitch 1x2 Wafer Pin Header) 3.0V Li battery is embedded to provide power for CMOS.

Pin#	Signal Name
1	VBAT
2	Ground

22. AUDIO (Line out connector)

HD Audio port an onboard Realtek codec is used to provide high quality audio I/O ports.

Line Out can be connected to a headphone or amplifier. (Diameter 3.5mm Jack)



Line out

23. LAN1 & LAN2 (RJ-45 Connector):

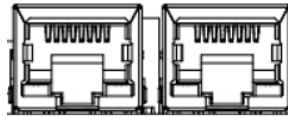

Status	Description
Orange On	1Gbps data rate
Green On	100Mbps data rate
Off	10Mbps data rate

Pin#	Definition	Pin No.	Definition
1	TX1+	4	TX3+
2	TX1-	5	TX3-
3	TX2+	7	TX4+
6	TX2-	8	TX4-

24. HDMI x2 (HDMI connector x2):

(2xHDMI 19P Connector), High Definition Multimedia Interface connector.

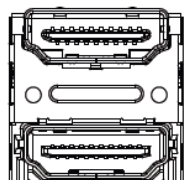

Pin	Definition	Pin	Definition	Pin	Definition	Pin	Definition
1	TX2p	11	GND	21	GND	31	CLKn
2	GND	12	CLKn	22	TX2n	32	NC
3	TX2n	13	NC	23	TX1p	33	NA
4	TX1p	14	NA	24	GND	34	DDC Clock
5	GND	15	DDC Clock	25	TX1n	35	DDC Data
6	TX1n	16	DDC Data	26	TX0p	36	GND
7	TX0p	17	GND	27	GND	37	5V
8	GND	18	5V	28	TX0n	38	Hot Plug Detect
9	TX0n	19	Hot Plug Detect	29	CLKp		
10	CLKp	20	TX2p	30	GND		

25. USB31_1, USB31_2 (USB 3.2 Gen 1 Connector):

The USB (Universal Serial Bus) port is for attaching USB devices such as keyboards, mouse, or other USB-compatible devices. USB 3.2 Gen 1 supports data transfer rates up to **5 Gbps**.

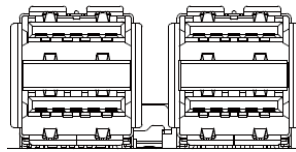

Pin#	Definition	Pin No.	Definition
1	5V	10	5V
2	D1n	11	D0n
3	D1p	12	D0p
4	GND	13	GND
5	USB3_RX1n	14	USB3_RX2n
6	USB3_RX1p	15	USB3_RX2p
7	GND	16	GND
8	USB3_TX1n	17	USB3_TX2n
9	USB3_TX1p	18	USB3_TX2p

Chapter 3 BIOS Setup

3.1 Introduction

BIOS (Basic input/output system) provides hardware detailed information and boot-up options, which include firmware to control, set-up and test all hardware settings. Therefore, BIOS is the communication bridge between OS/application software and hardware.

3.1.1 How to Entering into BIOS menu

Once the system is power on, press the <Delete> key as soon as possible to access into BIOS Setup program.

3.1.2 Function Keys to setup in BIOS Setup program

Function keys	Description
→←	Select Screen
↑↓	Select Item
Enter	Execute command or enter the submenu
+	Increase the numeric value or make changes
—	Decrease the numeric value or make changes
F1	General Help
F2	Previous Values
F3	Load Optimized Defaults Settings
F4	Save changes & Exit the BIOS Setup program
ESC	Exit the BIOS Setup program

3.2 The Main Menu

The main menu shows the basic system information.

Use arrow keys to move among the items.

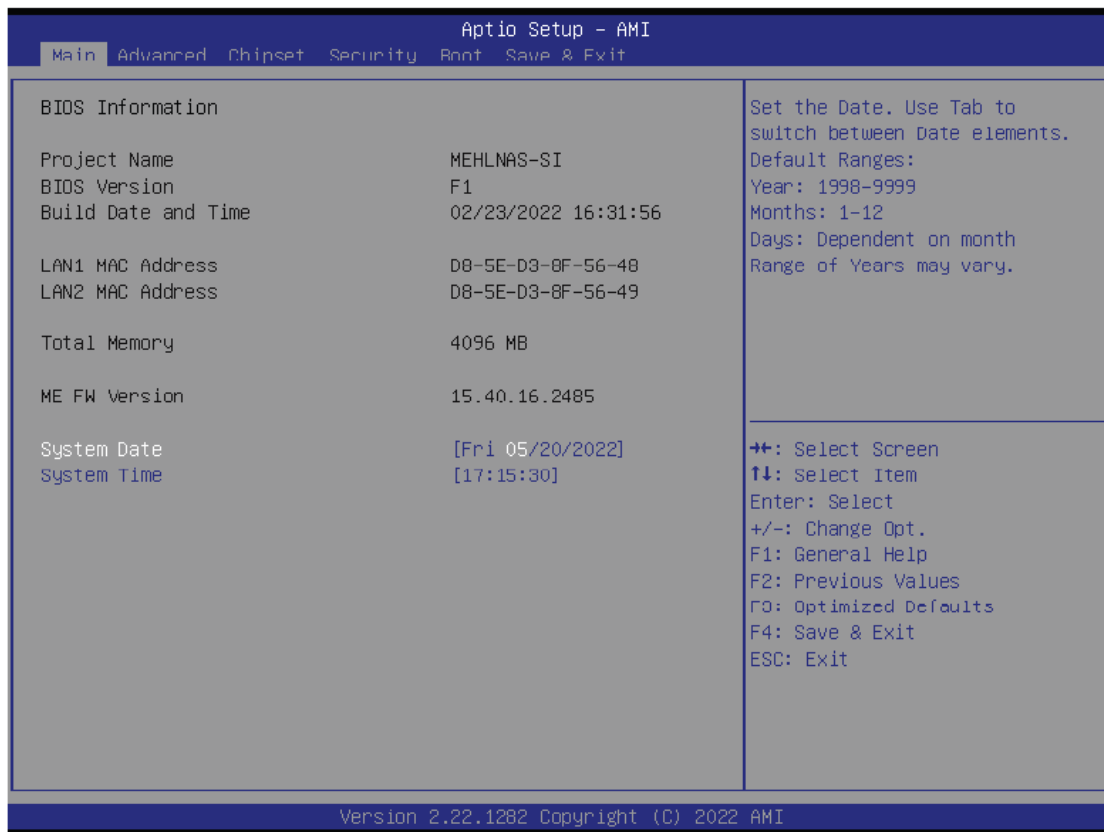

Items	Description
Project Name	Shows Project name information
BIOS Version	Shows the BIOS version of the system
Build Date and Time	Shows the Build Date and Time when the BIOS was created.
LAN1 MAC Address	Shows LAN1 MAC Address information
LAN2 MAC Address	Shows LAN2 MAC Address information
Total Memory	Shows the total memory size of the installed memory
ME FW version	Shows ME firmware version
System Date	Set the Date for the system (Format : Week - Month - Day - Year)
System Time	Set the time for the system (Format : Hour - Minute - Second)

3.3 Advanced

The Advanced menu is to configure the functions of hardware settings through submenu. Use arrow keys to move among the items, and press <Enter> to access into the related submenu.

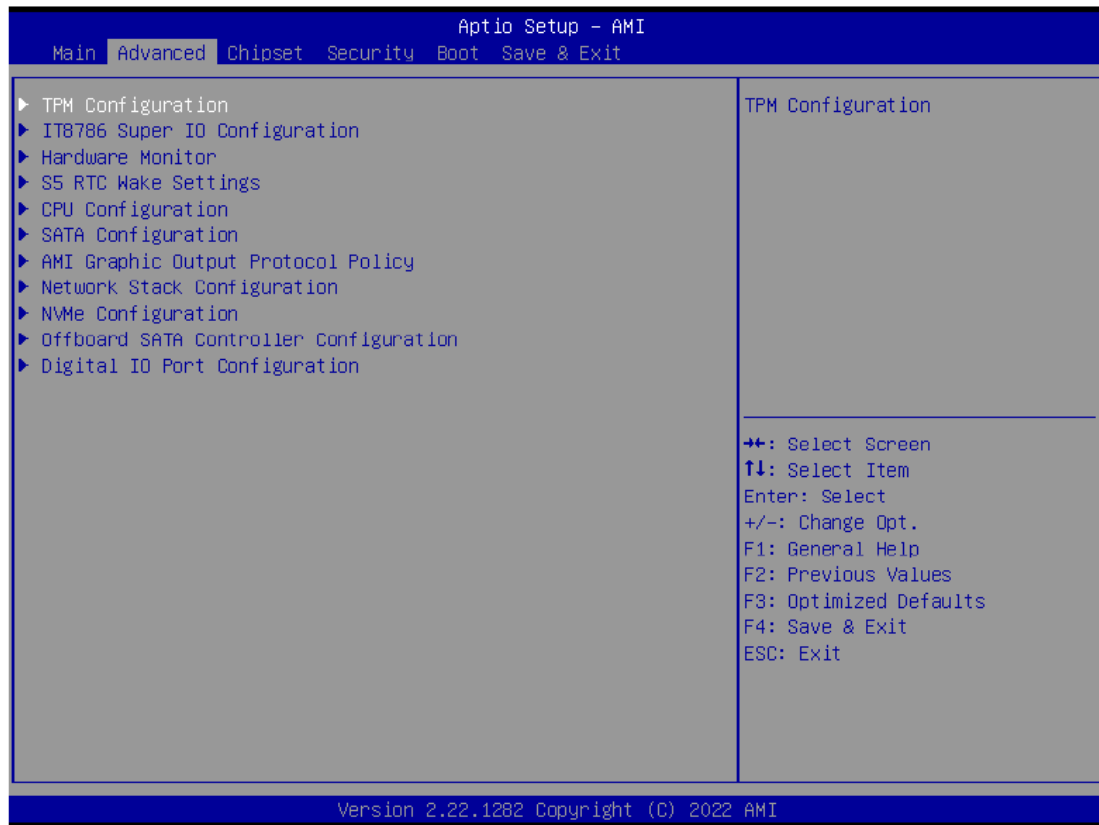

3.3.1 TPM Configuration

Use TPM Configuration submenu to choose TPM interface.

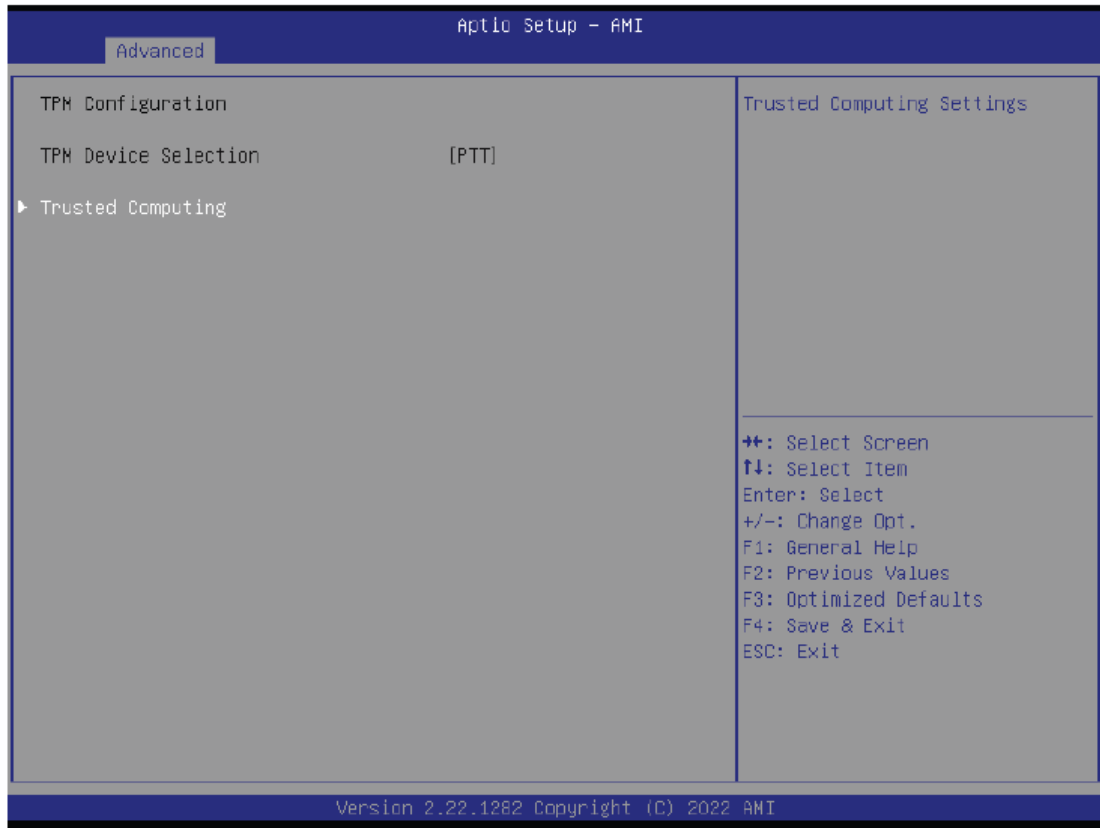

Item	Description
<p>TPM Device Selection</p>	<p>PTT : Internal TPM (Default setting)</p>

Trusted Computing: Shows TPM information, and TPM module configuration settings.

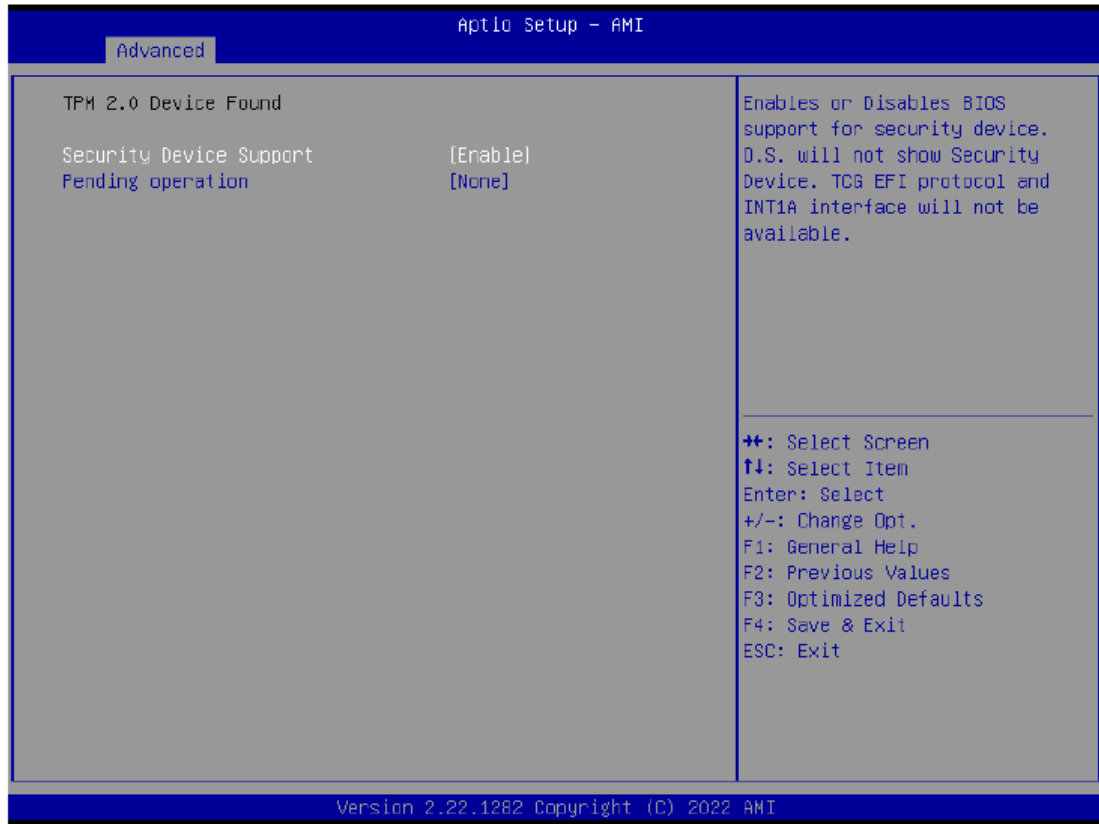

Item	Description
Security Device support	Enabled : Enables TPM feature (Default setting) Disabled : Disables TPM feature
Item	Description
Pending operation	None : No execution will be conducted (Default setting) TPM clear : Set to clear data on TPM

3.3.2 IT8786 Super IO Configuration

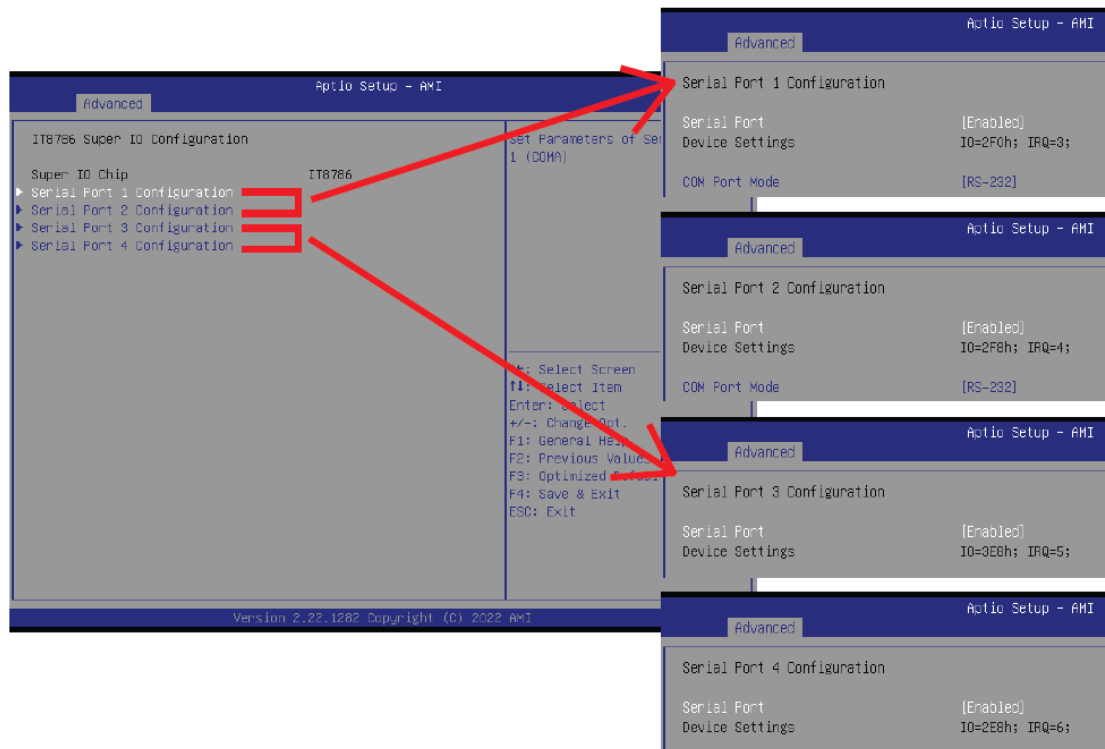

Item	Description
Super IO Chip	Shows Super I/O chip model
Serial Port 1 Configuration	Press [Enter] to configure advanced items : Serial Port : Enabled : Enables allows you to configure the serial port settings Disabled : if Disabled, displays no configuration for the serial port
Serial Port 2 Configuration	Device settings : Display the specified Serial Port base I/O address and IRQ COM Port Mode : Choose RS-232, RS-422, or RS-485 feature
Serial Port 3 Configuration	Press [Enter] to configure advanced items : Serial Port : Enabled : Enables allows you to configure the serial port settings Disabled : if Disabled, displays no configuration for the serial port
Serial Port 4 Configuration	Device settings : Display the specified Serial Port base I/O address and IRQ

3.3.3 Hardware Monitor

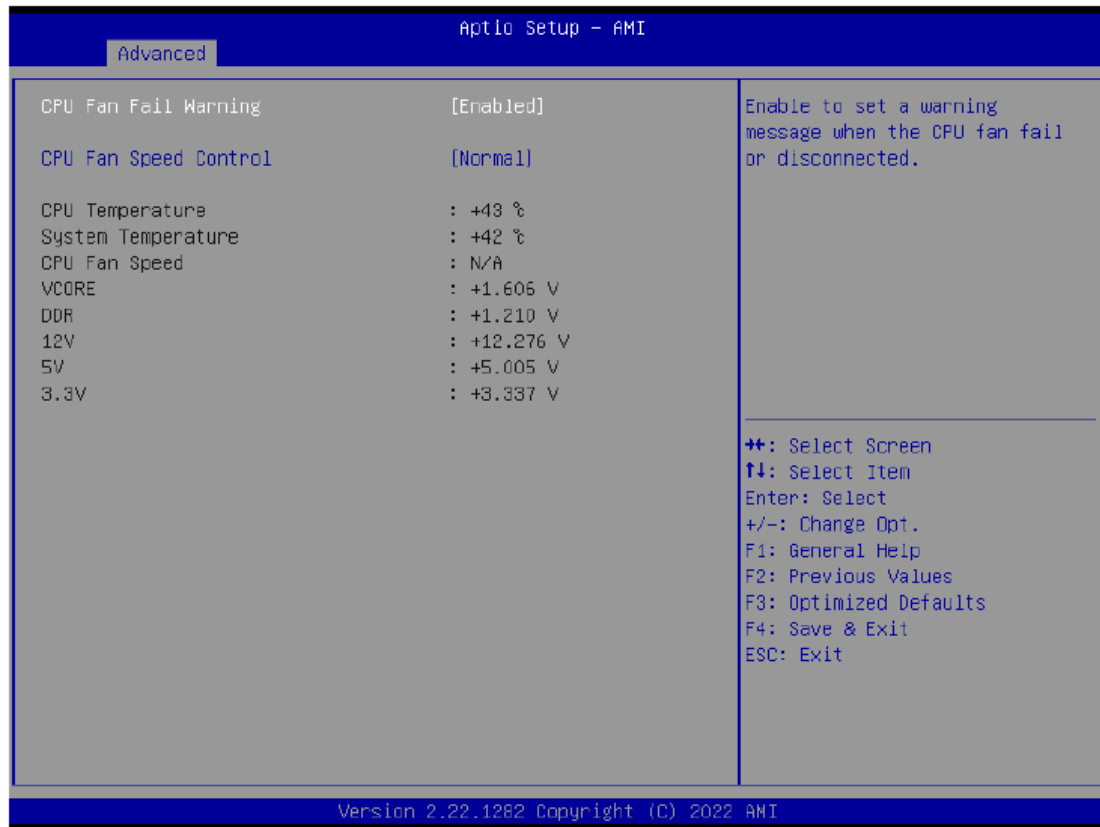

Item	Description
CPU Fan Fail Warning	Enabled : Enables CPU FAN Fail warning alert function (Default setting) Disabled : Disables CPU FAN Fail warning alert function
CPU Fan Speed Control	Normal : Fan speed set by BIOS default (Default setting) Full Speed : Set Fan operates at full speed
CPU temperature	Shows current CPU temperature
System temperature	Shows current system temperature
CPU Fan Speed	Shows current CPU fan Speed

Note: This model will not use the CPU Fan setting.

3.3.4 S5 RTC Wake Settings



Item	Description
Wake system from S5	Enable or Disable System to wake on a specific time. Disabled : Disables system to wake on a specific time (Default setting) Fixed Time : Enables system to wake on a specific time (Format : hr : min : sec)

3.3.5 CPU Configuration

This submenu shows detailed CPU information.

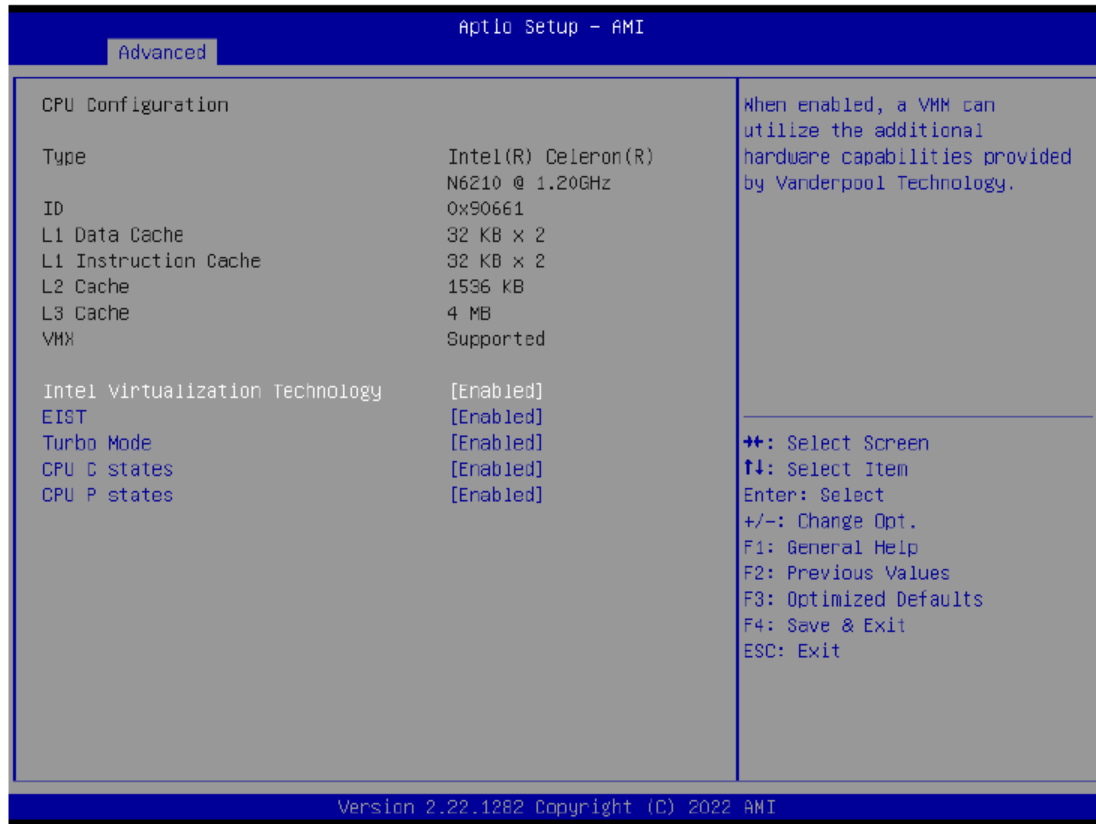

Item	Description
Intel Virtualization Technology	Virtualization enhanced by Intel® Virtualization Technology will allow a platform to run multiple operating systems and applications in independent partitions. With virtualization, one computer system can function as multiple virtual systems. Enabled : Enables Intel Virtualization Technology (Default setting) Disabled : Disables Intel Virtualization Technology
EIST	According to System loading, Enhanced Intel SpeedStep Technology (EIST) will automatically adjust the CPU voltage and core frequency to decrease heat and power consumption for power saving. Enabled : Enables EIST Technology (Default setting) Disabled : Disables EIST Technology
Turbo Mode	Enabled : Enables Turbo Mode (Default setting) Disabled : Disables Turbo Mode
CPU C states	Command CPU to enter into low power consumption mode when CPU is under idle mode. Enabled : Enables C states (Default setting) Disabled : Disables C states
CPU P states	CPU will adjust frequency depends on it's loading. Enabled : Enables CPU P states function (Default setting) Disabled : Disables CPU P states function

3.3.6 SATA Configuration

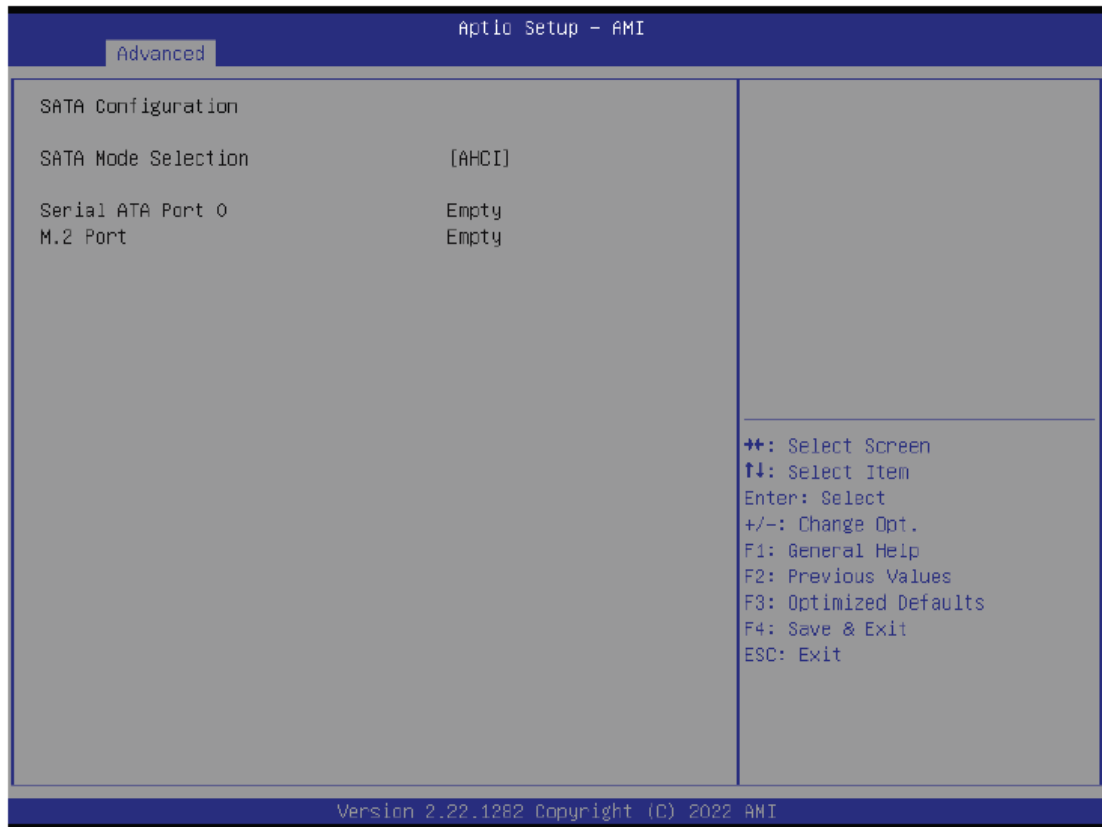

Item	Description
SATA Mode Selection	AHCI : Configures the SATA controllers to AHCI mode. (Default setting)
Serial ATA Port 0	shows 2.5" SATA HDD/SSD information
M.2	shows M.2 SATA interface SSD information

3.3.7 AMI Graphic Output Protocol Policy

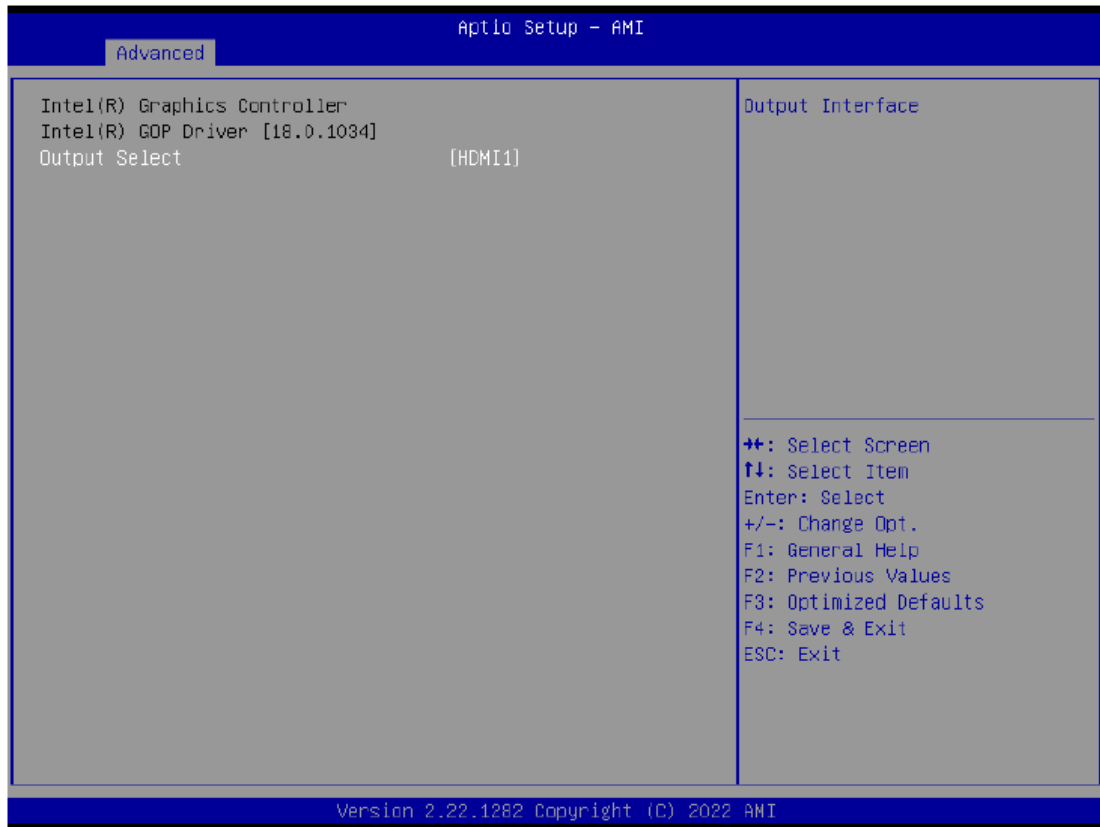

Item	Description
Output Select	Choose default monitor output when there are more than one monitor plugged on the motherboard.

3.3.8 Network Stack Configuration

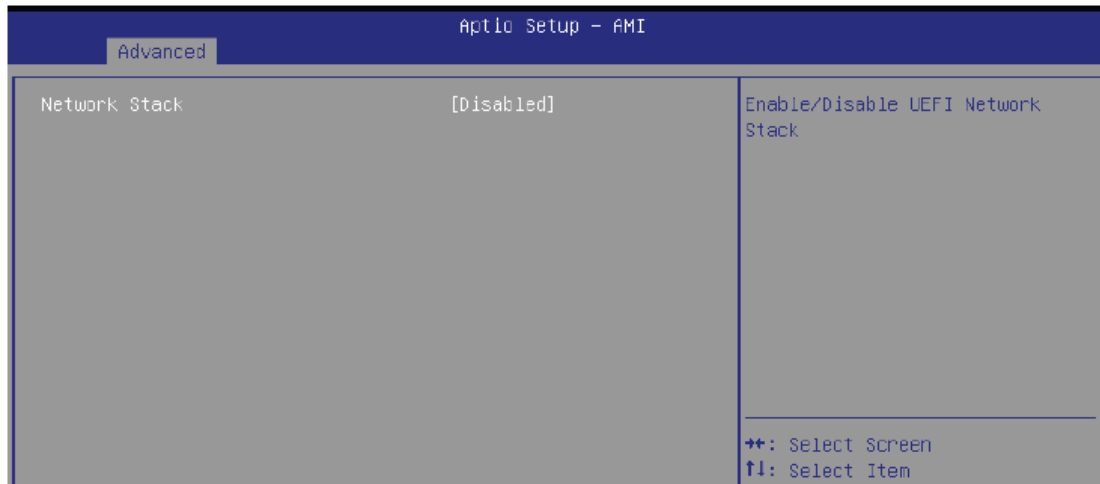

Item	Description
Network Stack	When system is power on, install LAN driver under UEFI mode Disabled : Disables UEFI Network Stack (Default setting) Enabled : Enables UEFI Network Stack
Ipv4 PXE Support	When Network stack is enabled : Disabled : Disables Ipv4 PXE Support Enabled : Enables Ipv4 PXE Support
Ipv6 PXE Support	When Network stack is enabled : Disabled : Disables Ipv6 PXE Support Enabled : Enables Ipv6 PXE Support

3.3.9 NVME Configuration

NVME Configuration shows information when your M.2 NVME PCIe SSD is installed



3.3.10 Offboard SATA Controller Configuration



3.3.11 Digital IO Port Configuration

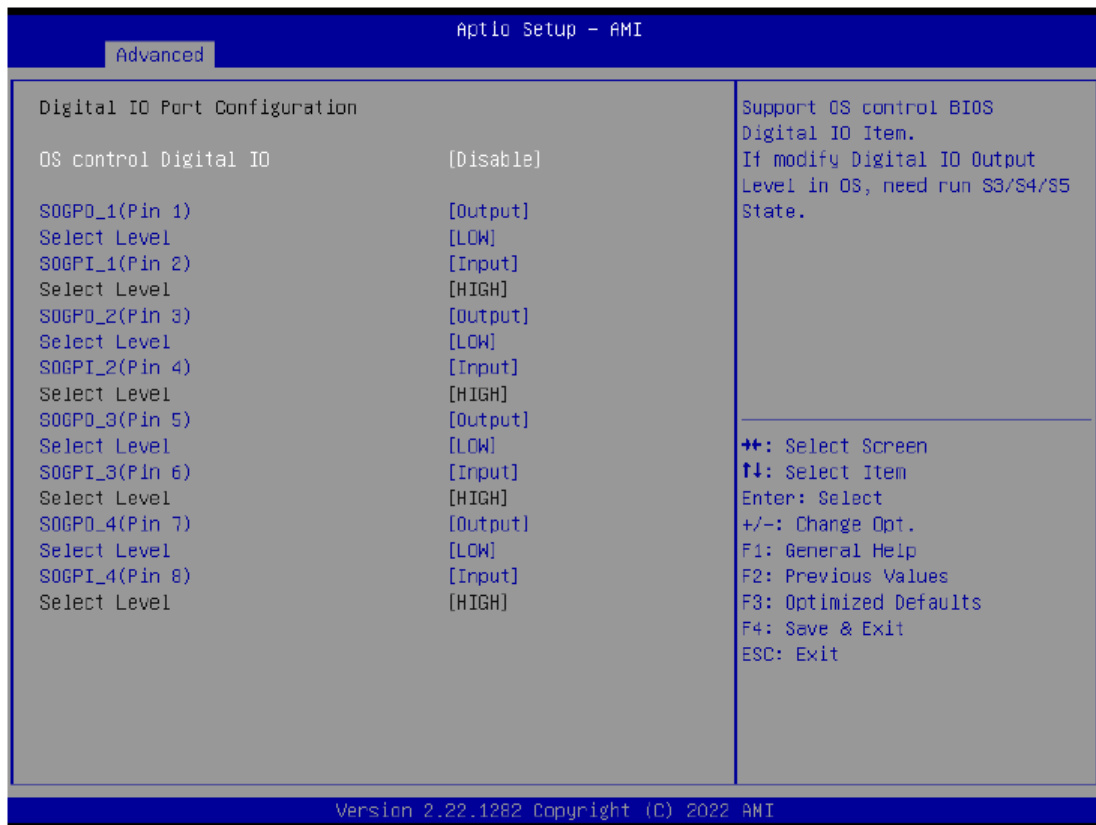

Item	Description
OS control Digital IO	<p>Disabled : If Digital IO Output value/level is modified in OS, they will not be memorized and kept. (Default setting)</p> <p>Enabled : If Digital IO Output value/level is modified in OS, they will be memorized and kept.</p>
SOGPO_1 (Pin 1) SOGPI_1 (Pin 2) SOGPO_2 (Pin 3) SOGPI_2 (Pin 4) SOGPO_3 (Pin 5) SOGPI_3 (Pin 6) SOGPO_4 (Pin 7) SOGPI_4 (Pin 8)	Configure Digital IO Input or Output values for each pin.

3.4 Chipset

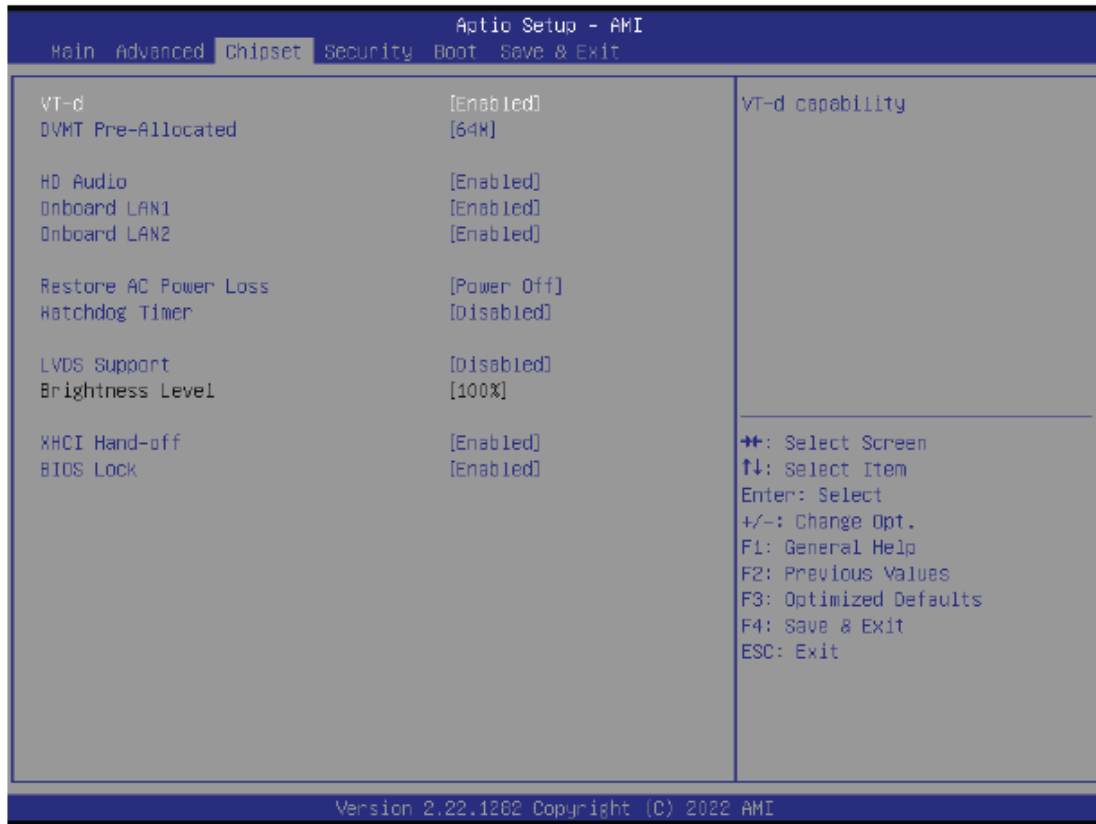

Item	Description
VT-d	Enabled : Enables VT-d function (Default setting) Disabled : Disables VT-d function
DVMT Pre-Allocated	Use DVMT Pre-Allocated to set the amount of system memory which is installed to the integrated graphics processor Option items : 32M , 64M(Default setting) , 128M , 256M
HD Audio	Enable/Disable onboard audio controller Enabled : Enables onboard audio controller (Default setting) Disabled : Disables onboard audio controller
Onboard LAN1 Onboard LAN2	Enable/Disable onboard LAN controller Enabled : Enables onboard LAN controller (Default setting) Disabled : Disables onboard LAN controller
Restore AC Power Loss	To set which option the system should returns if a sudden power loss occurred Power off : Do not power on when the power is back (Default setting) Power on : System power on when the power is back Last state : Restore the system to the state before power loss occurs
Watchdog Timer	Enable/Disable Watchdog Timer function Enabled : Enables Watchdog Timer function Disabled : Disabled Watchdog Timer function (Default setting)
LVDS Support	Disabled : Disables LVDS Support (Default setting) Enabled : Enables LVDS Support
Brightness Level	To modified the backlight brightness of the LVDS panel Option items : 10%, 20%, 30%, 40%, 50%, 60%, 70%, 80%, 90%, 100% (Default Setting)
XHCI Hand-off	Enable/Disable XHCI Hand-off function Enabled : Enables XHCI Hand-off function (Default setting) Disabled : Disables XHCI Hand-off function
BIOS Lock	Enable/Disable BIOS Lock function Enabled : Enables BIOS Lock function (Default setting) Disabled : Disabled BIOS Lock funtion

3.5 Security

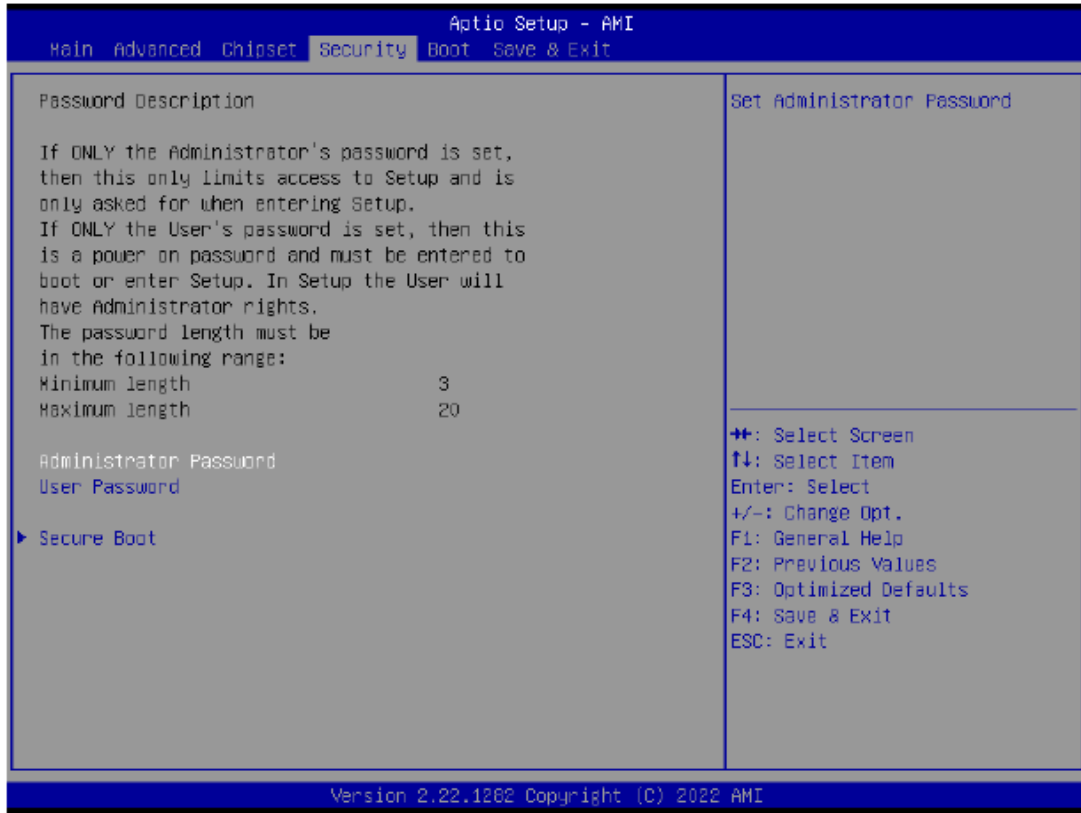

Item	Description
Administrator Password	To set up Administrator's password Minimum length : 3 Maximum length : 20
User Password	To set up User's password Minimum length : 3 Maximum length : 20
Secure Boot	Press <Enter> to configure the advanced items



Item	Description
Secure Boot	Secure Boot requires all the applications that are running during the booting process to be pre-signed with valid digital certificates Enabled : Enables Secure Boot function Disabled : Disables Secure Boot function (Default setting)
Secure Boot Mode	Standard : Standard mode Custom : Custom mode (Default setting)
Restore Factory Keys	To restore factory settings Yes : Agree to restore factory settings No : Cancel to restore factory settings
Reset To Setup Mode	Yes : Agree to setup mode No : Cancel to setup mode
Key Management	Enables expert users to modify Secure boot policy variables without full authentication Press <Enter> to configure the advanced items

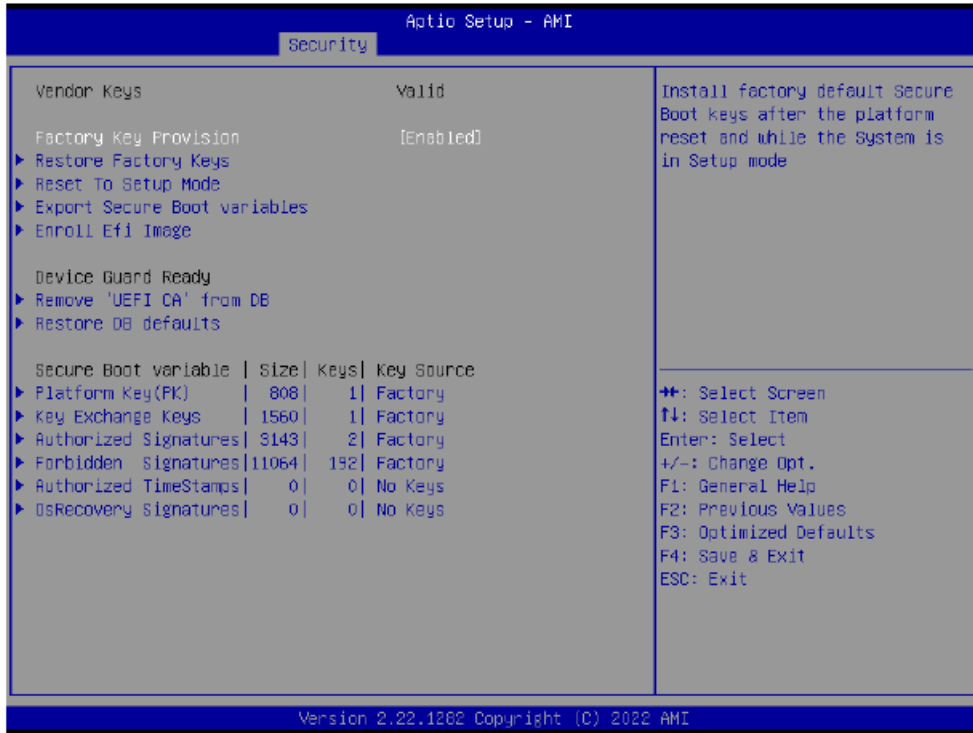

Item	Description
Factory Key Provision	Install factory default Secure Boot keys after the platform reset and while the system is in Setup mode Enabled : Enables Factory Key Provision (Default setting) Disabled : Disables Factory Key Provision
Restore Factory Keys	To restore factory settings Yes : Agree to restore factory settings No : Cancel to restore factory settings
Reset To Setup Mode	Yes : Agree to setup mode No : Cancel to setup mode
Export Secure Boot variables	Copy NVRAM content of Secure Boot variables to files in a root folder on a file system device
Enroll Efi Image	Allow the image to run in Secure Boot mode
Remove 'UEFI CA' from DB	To remove 'UEFI CA' from database Yes : Agree to remove 'UEFI CA' from database No : Cancel to remove 'UEFI CA' from database
Restore DB defaults	Restore DB variables to factory defaults Yes : Agree to restore DB defaults No : Cancel to restore DB defaults

Item	Description
Platform Key (PK)	These items allows you to enroll factory defaults or load Certificates from a file.
Key Exchange Keys	
Authorized Signatures	
Forbidden Signatures	
Authorized TimeStamps	
OsRecovery Signatures	

3.6 Boot

This Boot menu allows you to set/change system boot options

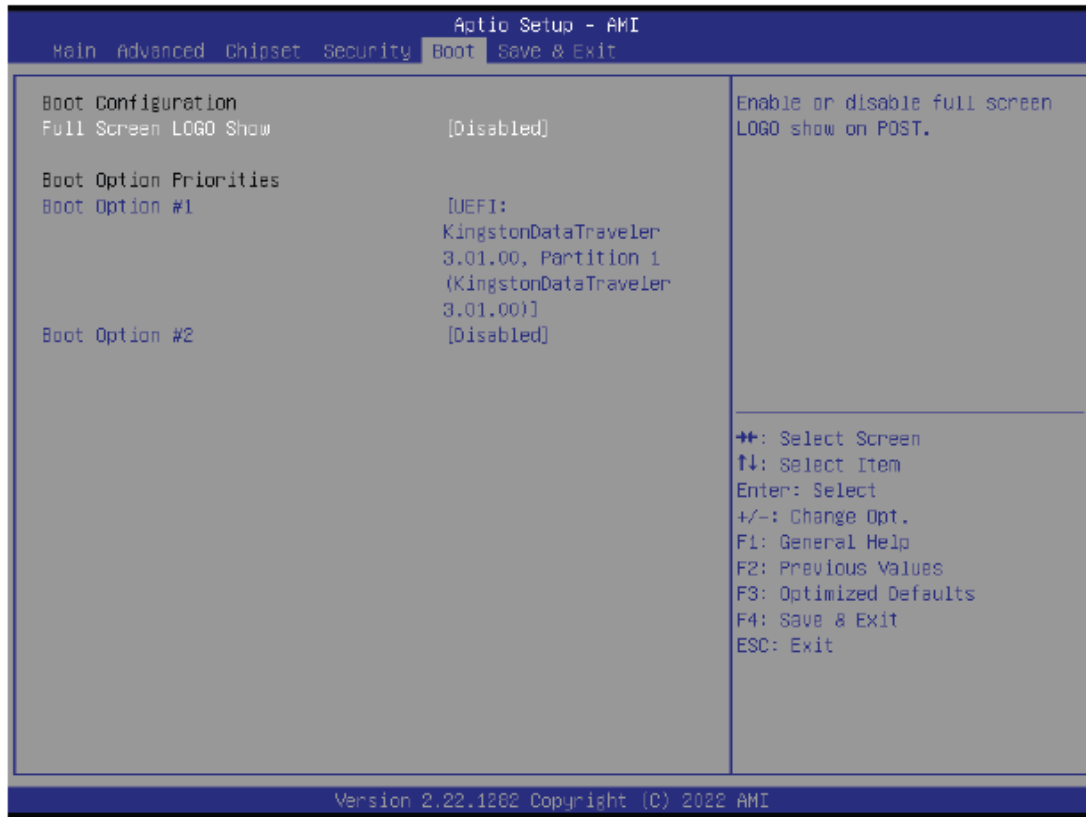

Item	Description
Full Screen LOGO Show	Enable/Disable full screen LOGO show on POST screen Enabled : Enables Full screen LOGO Show on POST screen Disabled : Disables Full screen LOGO Show on POST screen (Default setting)
Boot Option #1 Boot Option #2	Shows the information of the storage that be installed in the system Choose/set the boot priority

3.7 Save & Exit

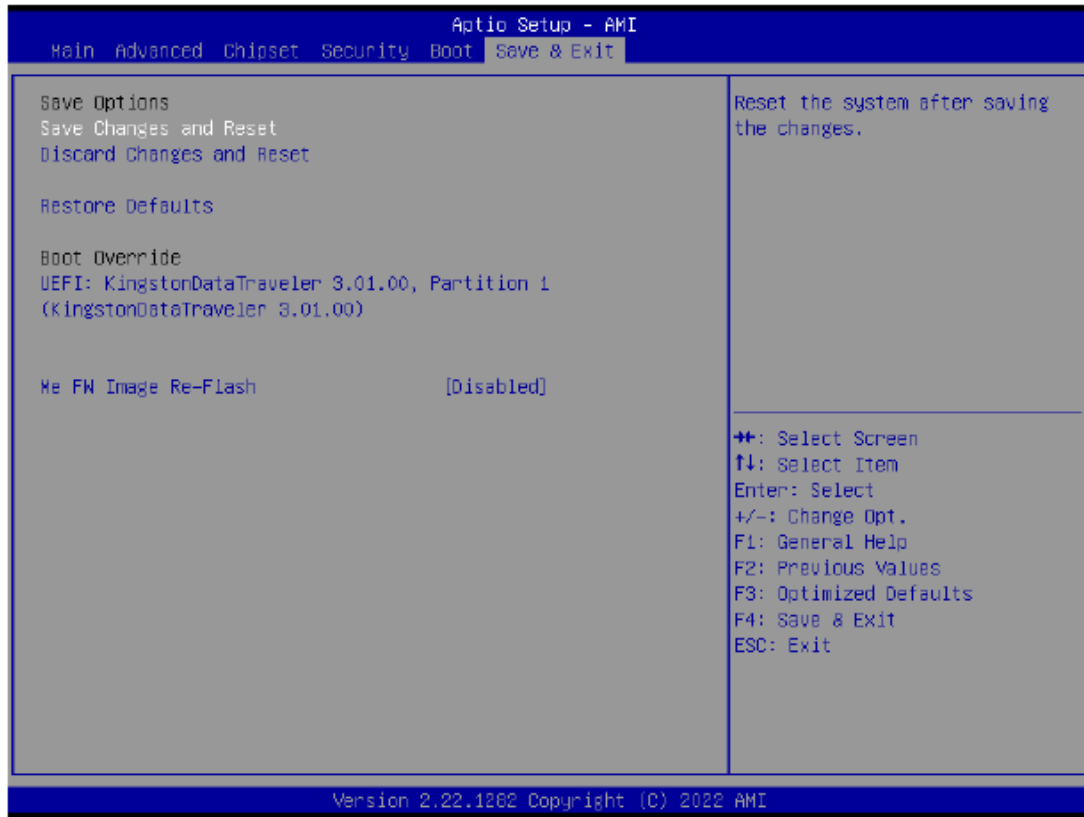

Item	Description
Save Changes and Reset	After configuring all the options that you wish to change, choose this option to save all the changes and reboot the system Yes : Agree to save and reset No : Cancel to save and reset
Discard Changes and Reset	Choose this option to reboot the system without saving any changes Yes : Agree to discard changes and reset No : Cancel to discard changes and reset
Restore Defaults	Restore/Load default values for all the setup options Yes : Agree to load optimized defaults No : Cancel to load optimized defaults
Me FW Image Re-Flahs	Enable/Disable Me FW image re-flash function Enabled : Enables Me FW image re-flash function Disabled : Disables Me FW image re-flash function (Default setting)

Chapter 4 Installation Setup

4.1 Wi-Fi6 & Bluetooth 5.2 Module Installation Kit List

4.1.1 The following components are required to install the Wi-Fi/
Bluetooth (BT) module

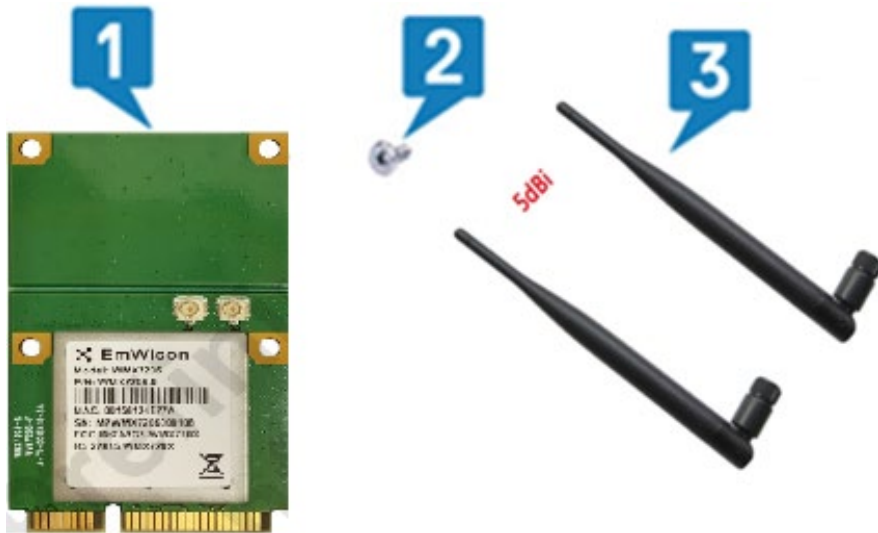

1. Wi-Fi Module Card
3. External Antenna x2

2. Screw (released from MB)

4.1.2 Align and insert the Wi-Fi card into the Mini PCIe slot

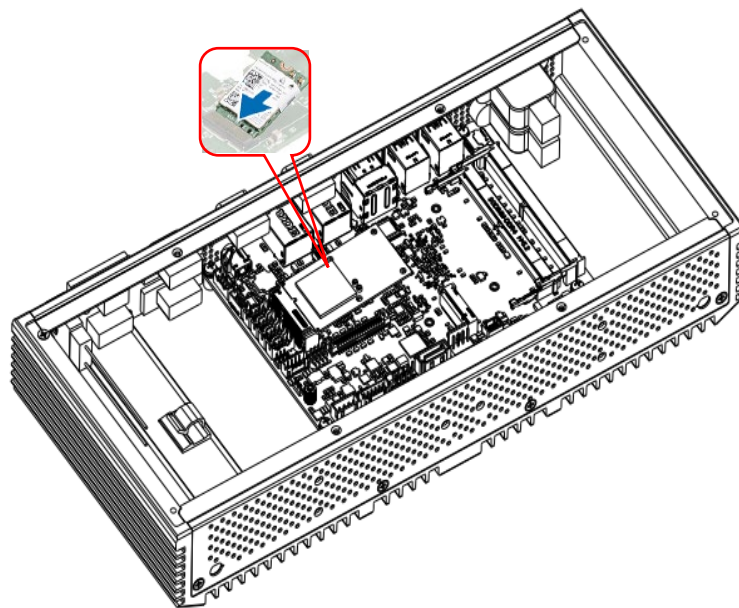

4.1.3 Tighten the single screw (M2x2.5) to secure both the Wi-Fi card to the Mainboard

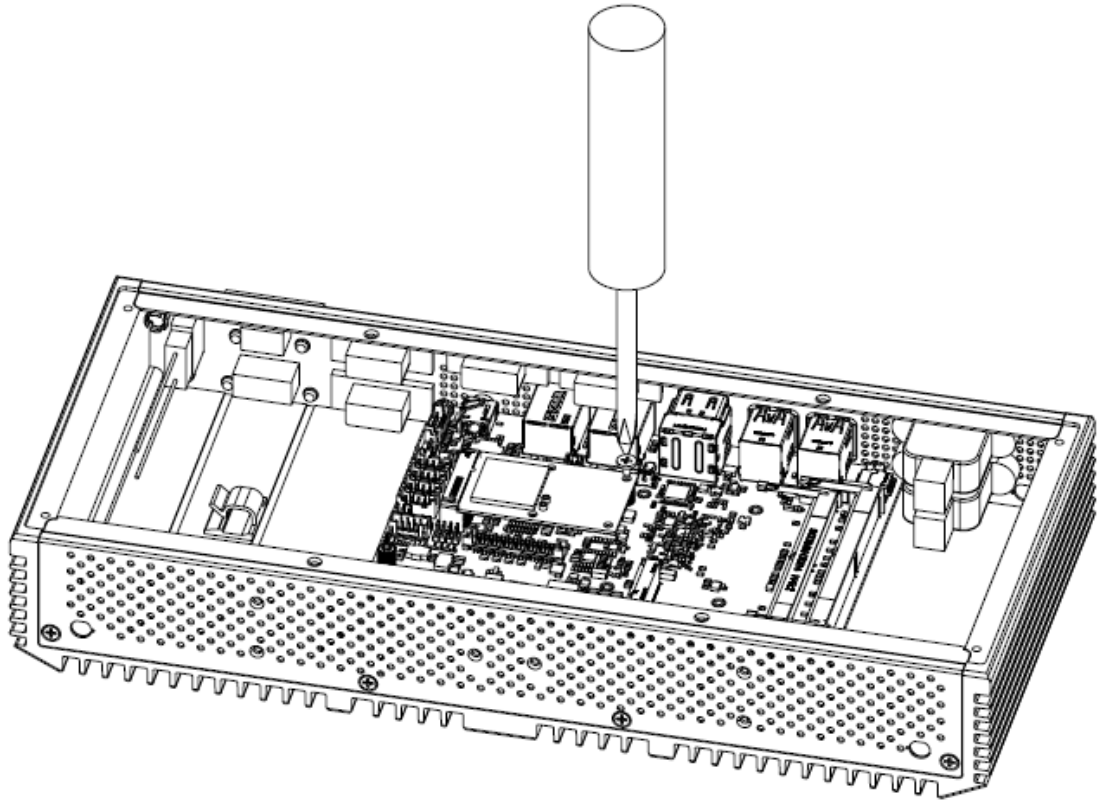

Figure 4.2: Tighten the single screw (M2x2.5) Location

4.1.4 Connect the IPEX1 Right & Left cable 2Pcs on the Wi-Fi Card

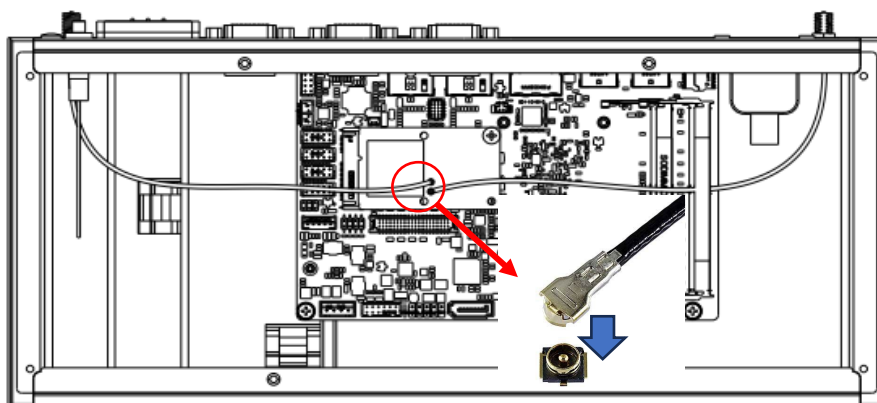

Figure 4.3: IPEX1 Right & Left cable Location

4.1.5 Tighten the secure both the external antenna cable

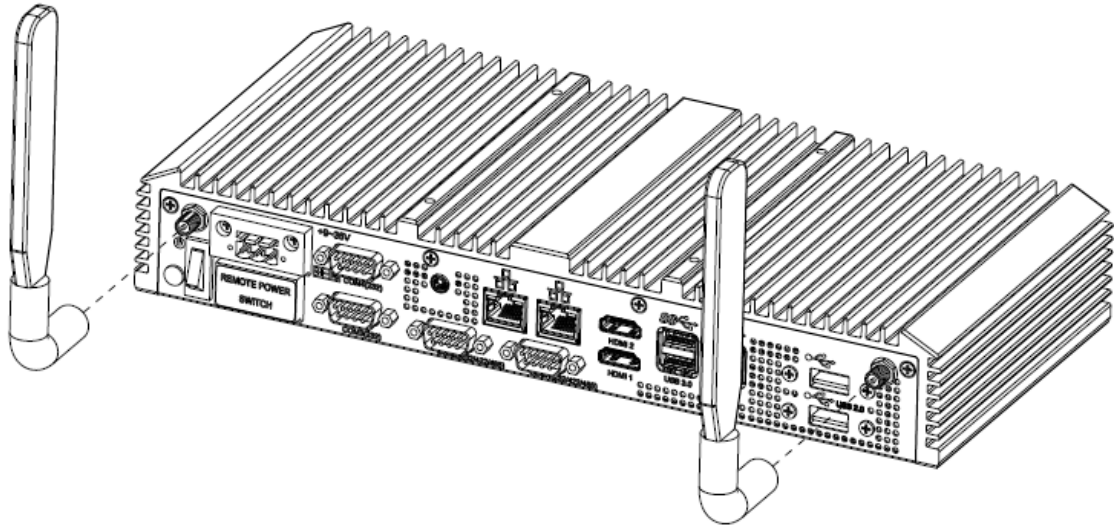

Figure 4.4: Install external antenna Location

4.2 4G & LTE Module Installation Kit List

4.2.1 The following components are required to install the 4G/ LTE module



1. 4G/LTE Module Card
3. 4G/LTE External Antenna x2

2. Screw (released from MB)

4.2.2 Align and insert the 4G/LTE card into the Mini PCIe slot

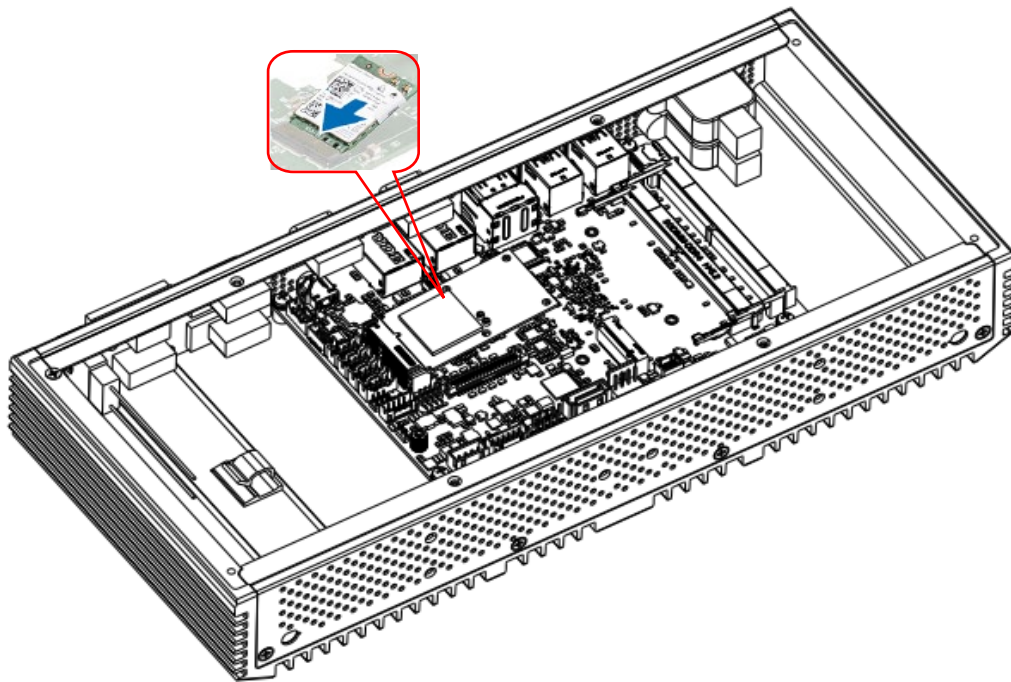

Figure 4.5: Insert the 4G/LTE card Location

4.2.3 Tighten the single screw (M2x2.5) to secure both the 4G/LTE Card to the MainBoard

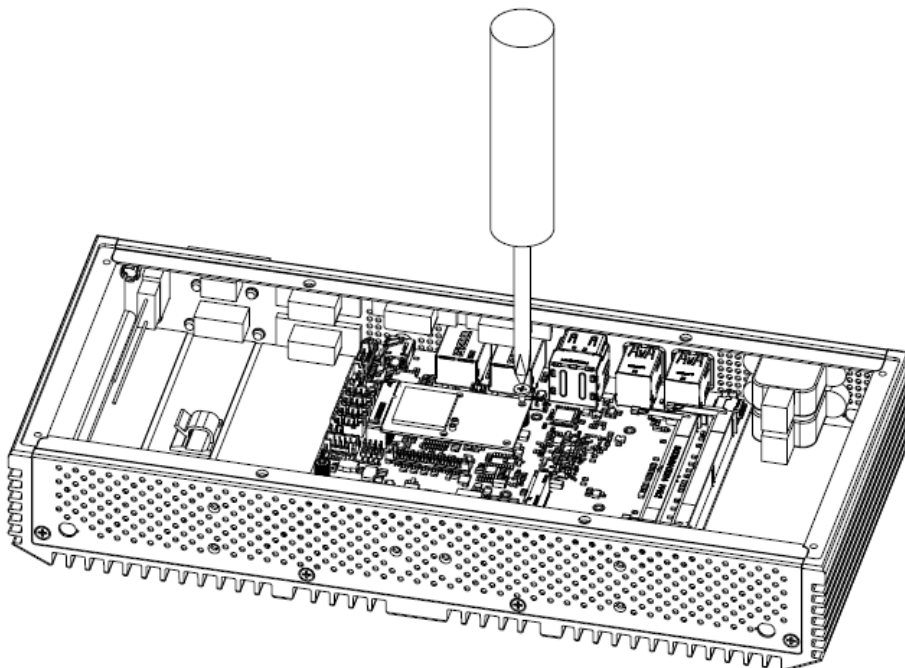

Figure 4.6: Tighten the single screw (M2x2.5) Location

4.2.4 Connect the IPEX4 Right & Left cable on the 4G/LTE card

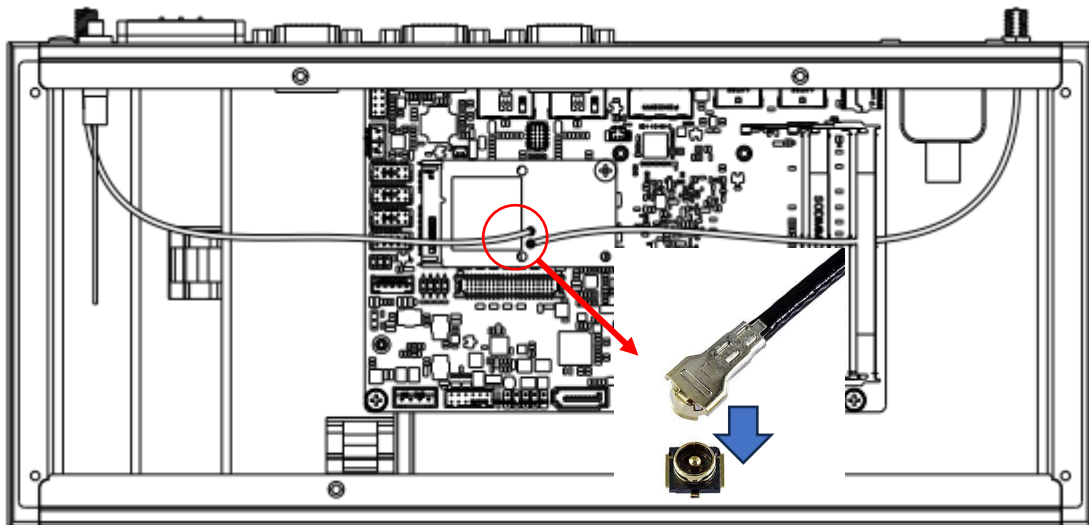

Figure 4.7: IPEX4 Right & Left cable Location

4.2.5 Tighten the secure both the external antenna cable

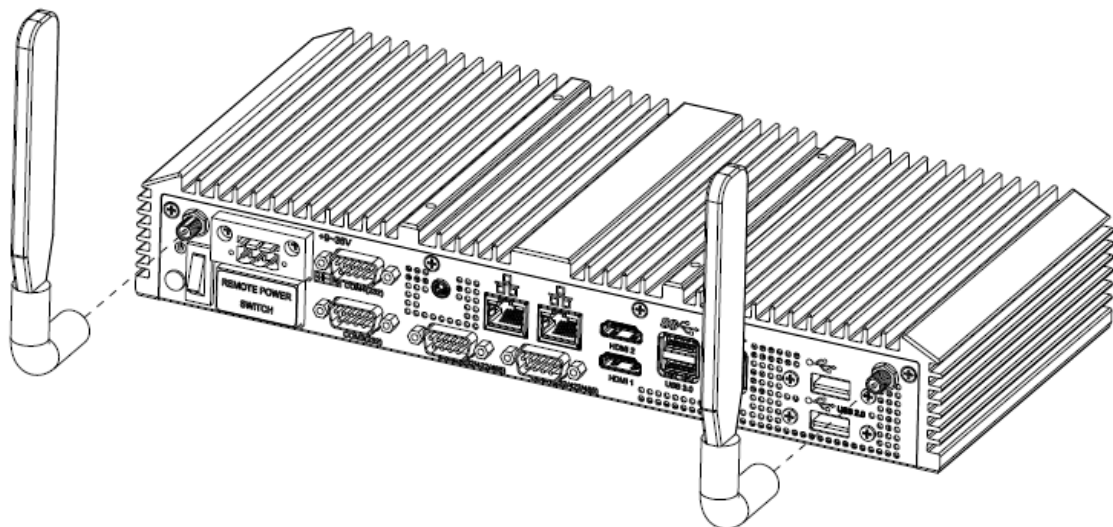

Figure 4.8: Install external antenna Location